



SERVICE TRAINING NOTES

TRIUMPH
2997 cc
V8 ENGINE

STAG



TO BE USED WITH FILMSTRIP
No. 1005

Issued by:

SALES AND SERVICE TRAINING CENTRE

**BRITISH LEYLAND UK LIMITED
RADFORD, COVENTRY, ENGLAND**

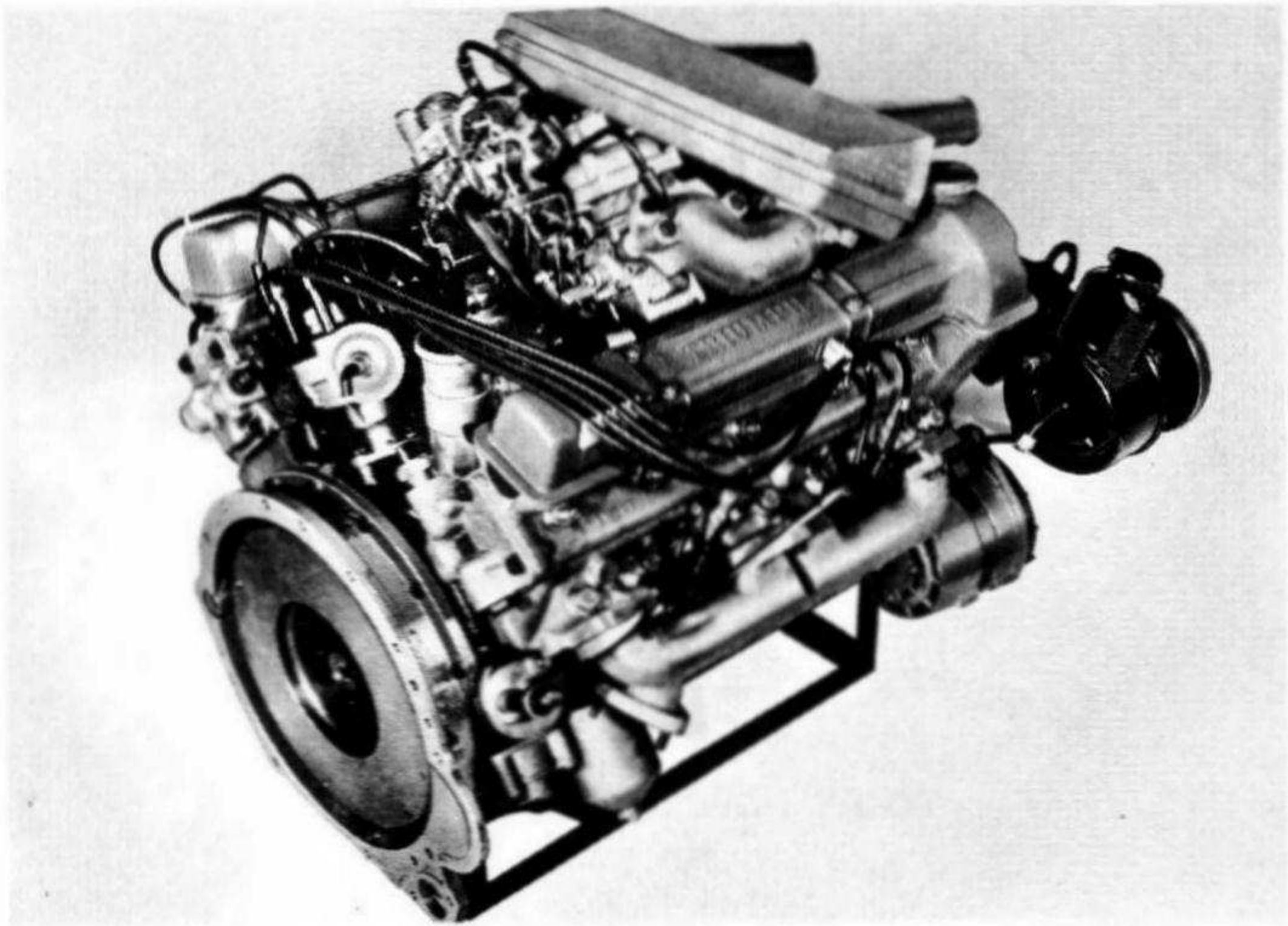

INTRODUCTION

This booklet and the accompanying filmstrip show the main features of the Triumph V8 Engine.

MAIN SECTIONS

- Part 1 Cylinder Head Removal and Overhaul
- Part 2 Lubrication
- Part 3 Crankcase Ventilation
- Part 4 Crankshaft and Assemblies
- Part 5 Timing Chain Assembly
- Part 6 Carburettor Servicing
- Part 7 Alternator
- Part 8 Torque Control Unit and Fan Assembly
- Part 9 Thermostat and Cooling System
- Part 10 Air Cleaner
- Part 11 Exhaust Manifolds and Starter Motor
- Part 12 Water Pump Removal and Overhaul

It is intended that the filmstrip should form the basis of a lecture. The subject matter can be elaborated or abbreviated to suit the type of audience. The booklet itself provides a handy pocket manual for ready reference.

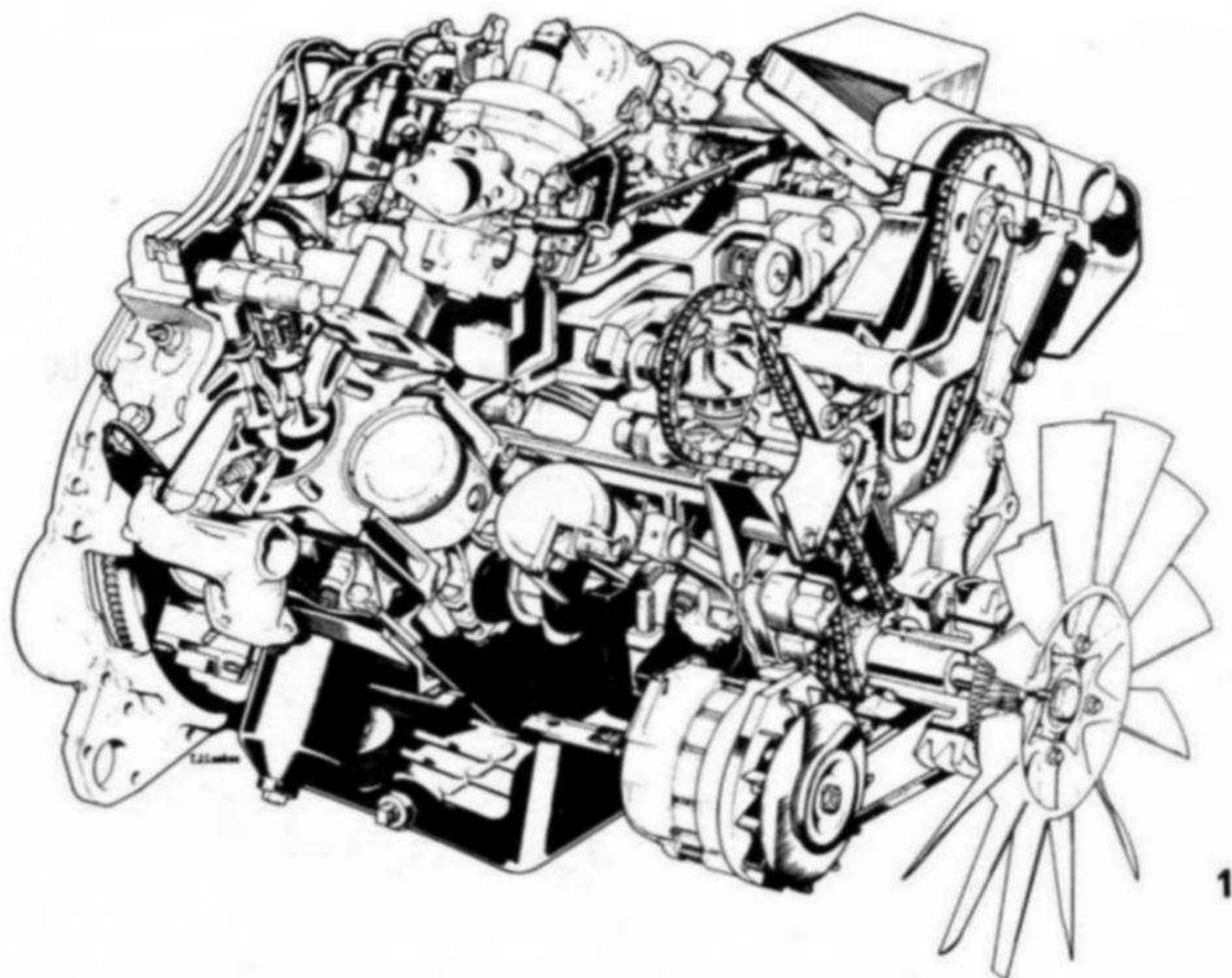

FRAME 1

The cut-away illustration of the Triumph V8 Engine above shows the location of the major components.

TECHNICAL DATA

The engine is an eight-cylinder 'V' configuration which is naturally aspirated, is water-cooled, and has a wet sump lubrication system.

Capacity	182.9 cu. in. (2997 c.c.)
Bore	3.385" (86 mm.)
Stroke	2.539" (64.5 mm.)
Compression ratio	9.25 : 1
Maximum power	145 b.h.p. nett @ 5,500 r.p.m.
Maximum torque	2040 lb. in. @ 3,500 r.p.m.
Firing order..	1, 2, 7, 8, 4, 5, 6, 3
Engine Commission No. Prefix	LF1HE and upwards

Throughout this booklet all references to left- and right-hand assemblies are as viewed from the driving position in the car.

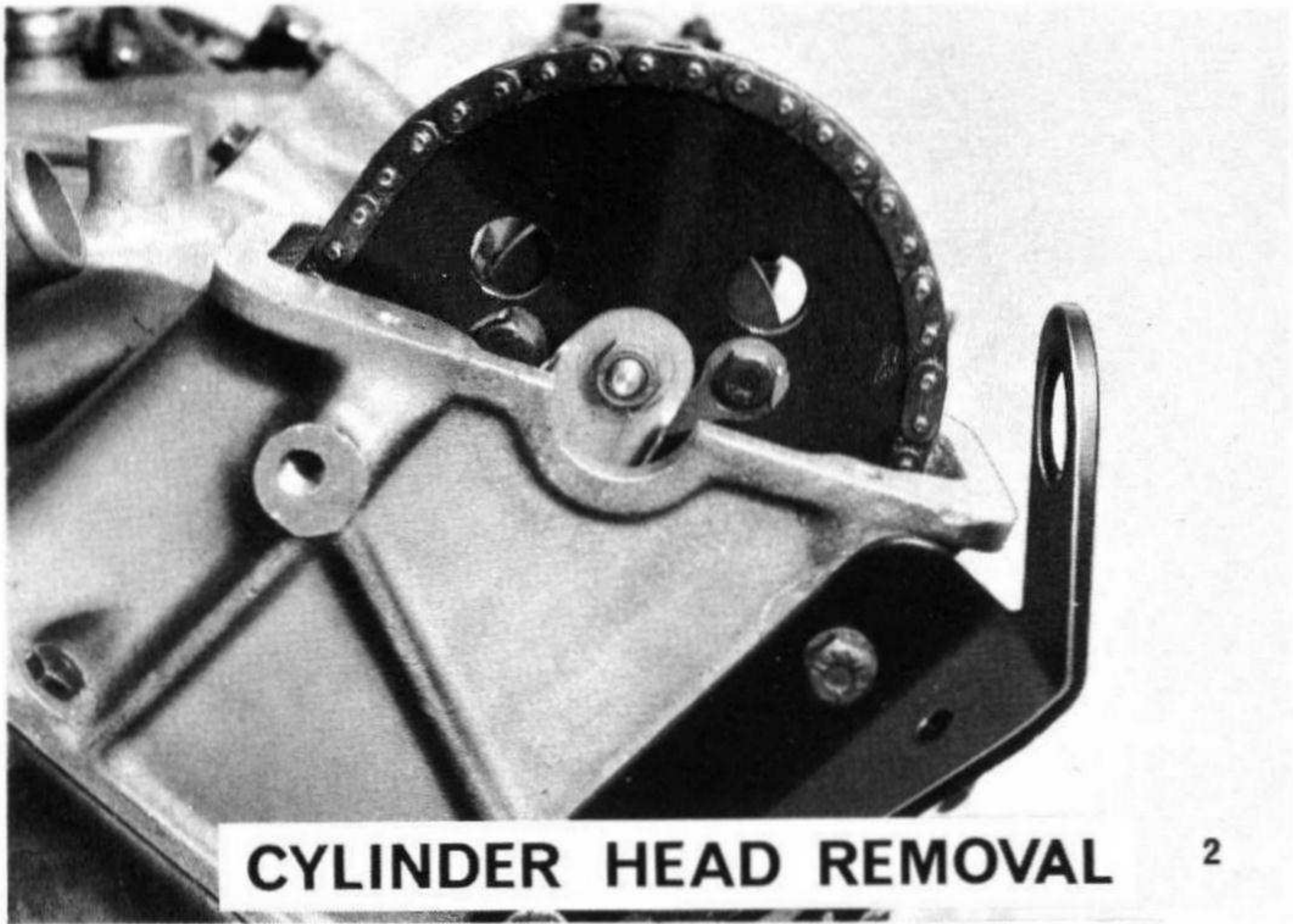

FRAME 2

PART 1

CYLINDER HEAD REMOVAL

Before removing the cylinder head turn engine to T.D.C. No. 2 cylinder firing.

Remove the throttle linkage and carburetors.

Remove the bolts securing the appropriate head to the inlet manifold.

Remove the camshaft cover.

Remove the exhaust manifold if engine is in car.

Before removing the camshaft chain sprocket **ENSURE** the sprocket is tightly secured to the sprocket mounting bracket.

NOTE: A nut from one of the camshaft bearing caps may be used.

Knock back the tab washers and remove the two bolts securing the sprocket to the camshaft. The sprocket may then be pulled free from the camshaft.

Failure to observe these precautions will result in the chain sprocket dropping slightly, thus allowing the timing chain tensioner to expand to the non-retractable condition.

If this occurs, it will be necessary to remove the front timing cover and appropriate tensioner and reset the timing as described on pages 47–56.

Remove the cylinder head studs using tool No. S350.

Remove the cylinder head bolt at either end of the head and replace by two long studs to facilitate dismantling.

Remove all other bolts, including the special bolts securing the front of the head to the timing cover.

Remove the cylinder head and collect gasket.

NOTE: When refitting cylinder head always tighten head to inlet manifold before tightening cylinder head bolts to the sequence shown in Frame 3.

CYLINDER HEAD TIGHTENING SEQUENCE

50-55 lb ft (6.9-7.6 kg. m.)

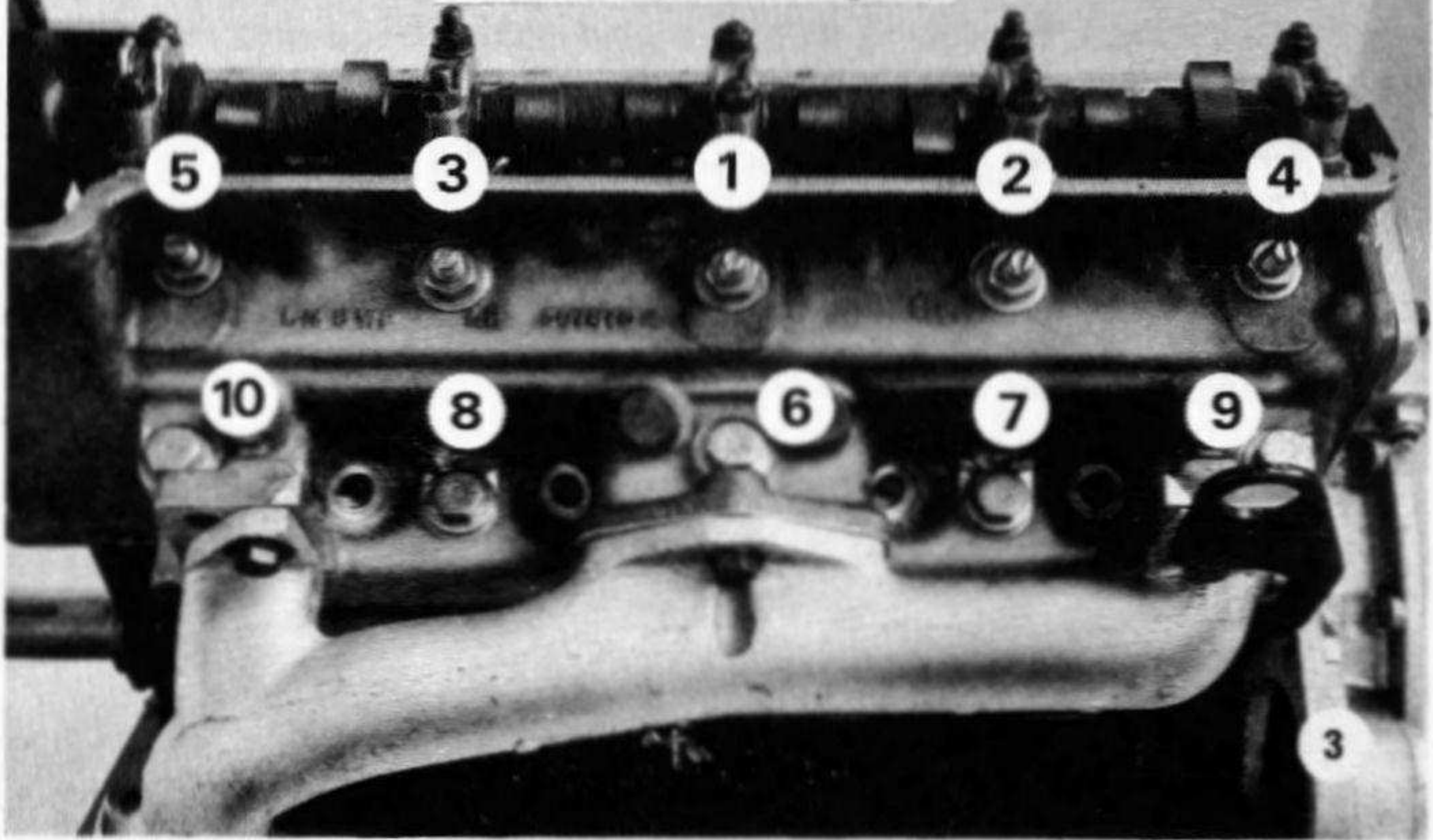

FRAME 3

CYLINDER HEAD

The cylinder head nuts and bolts should be tightened progressively in the sequence shown above.

Tighten all cylinder head nuts and bolts to 50-55 lb. ft. (6.9-7.6 kg. m.).

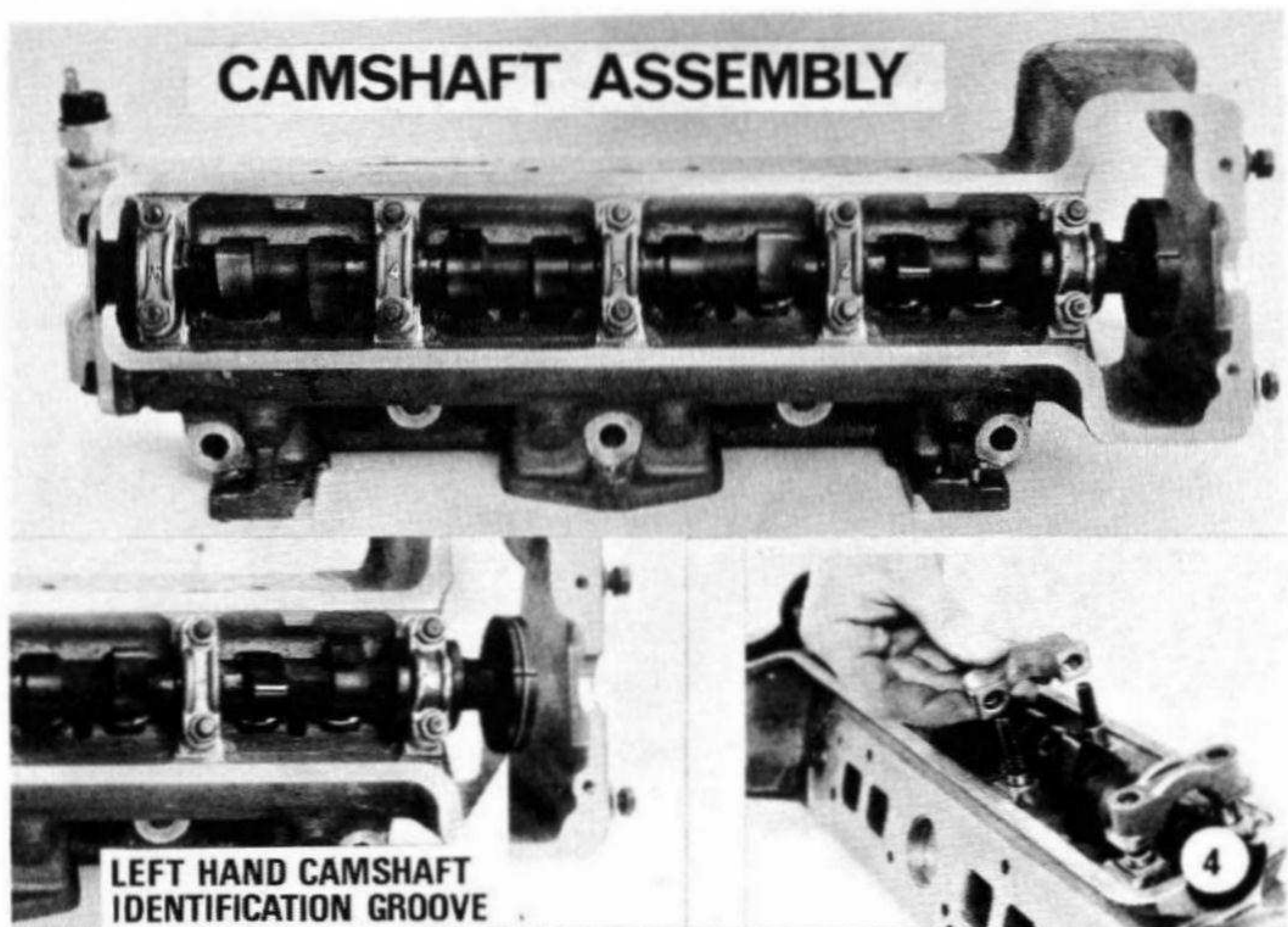

FRAME 4

CAMSHAFT

The camshaft has five bearings, which run in the alloy head.

The camshafts are 'handed', and the left-hand camshaft can be identified by an annular groove cut in the flange. The right-hand camshaft is unmarked.

No. 1 bearing cap has indents on the top face for timing purposes.

The bearing caps locate onto long and short dowels to prevent incorrect fitting.

Progressively slacken bearing cap nuts, otherwise damage to the camshaft may result.

When refitting, tighten camshaft bearing cap nuts to 12–14 lb. ft. (1.7–1.9 kg. m.).

NOTE: Great care should be taken when handling cylinder head with the camshaft in position, due to the valves projecting below the face of the head.

VALVE ASSEMBLY

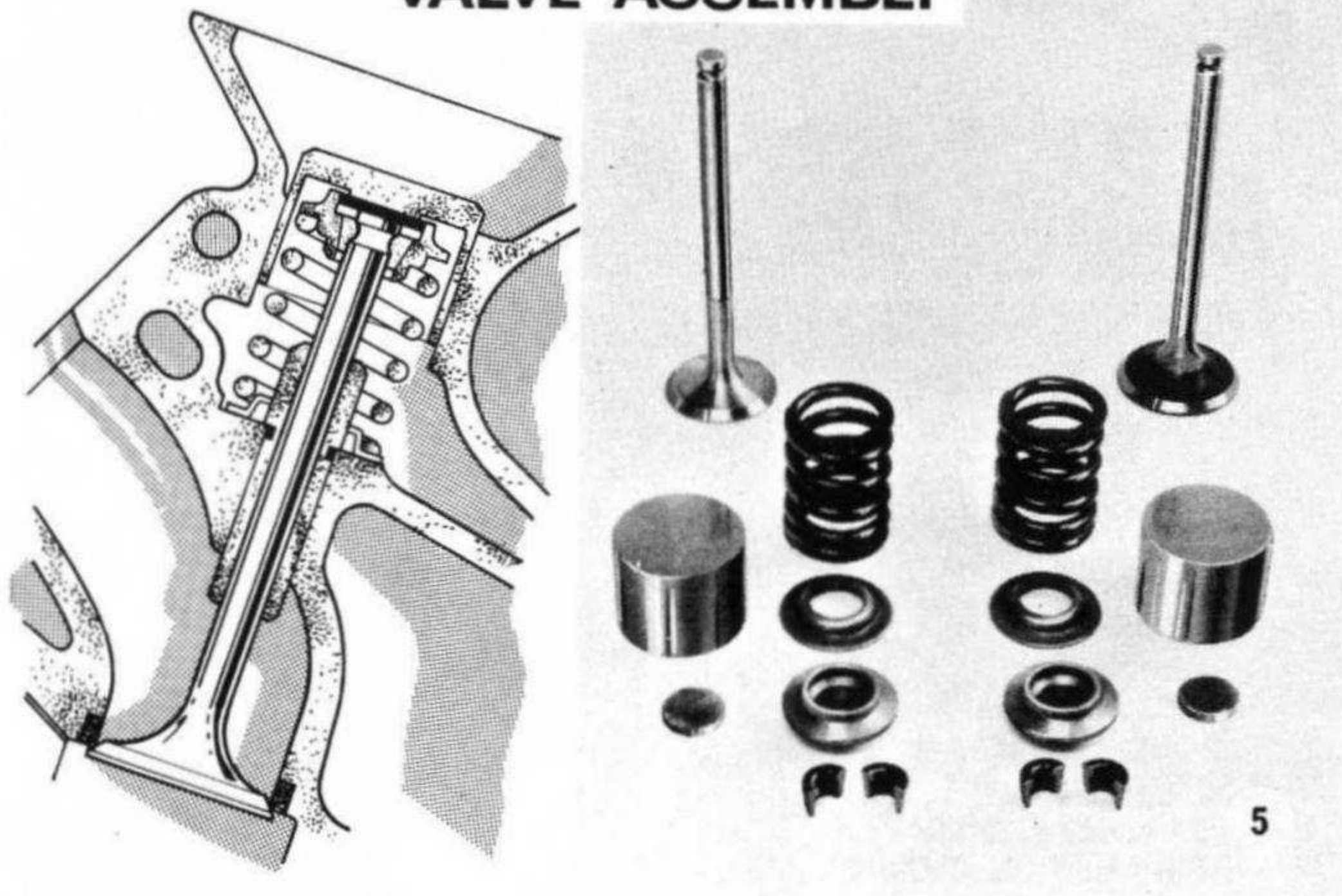

FRAME 5

TAPPETS

Number each tappet and location when removing them from the cylinder head.

Always place the adjusting pallets with their appropriate tappet.

Failure to carry out these instructions will cause incorrect tappet clearances.

An exploded view of the valve assembly items is shown in the illustration.

NOTE: The valve springs must be fitted with the close coil to the bottom.

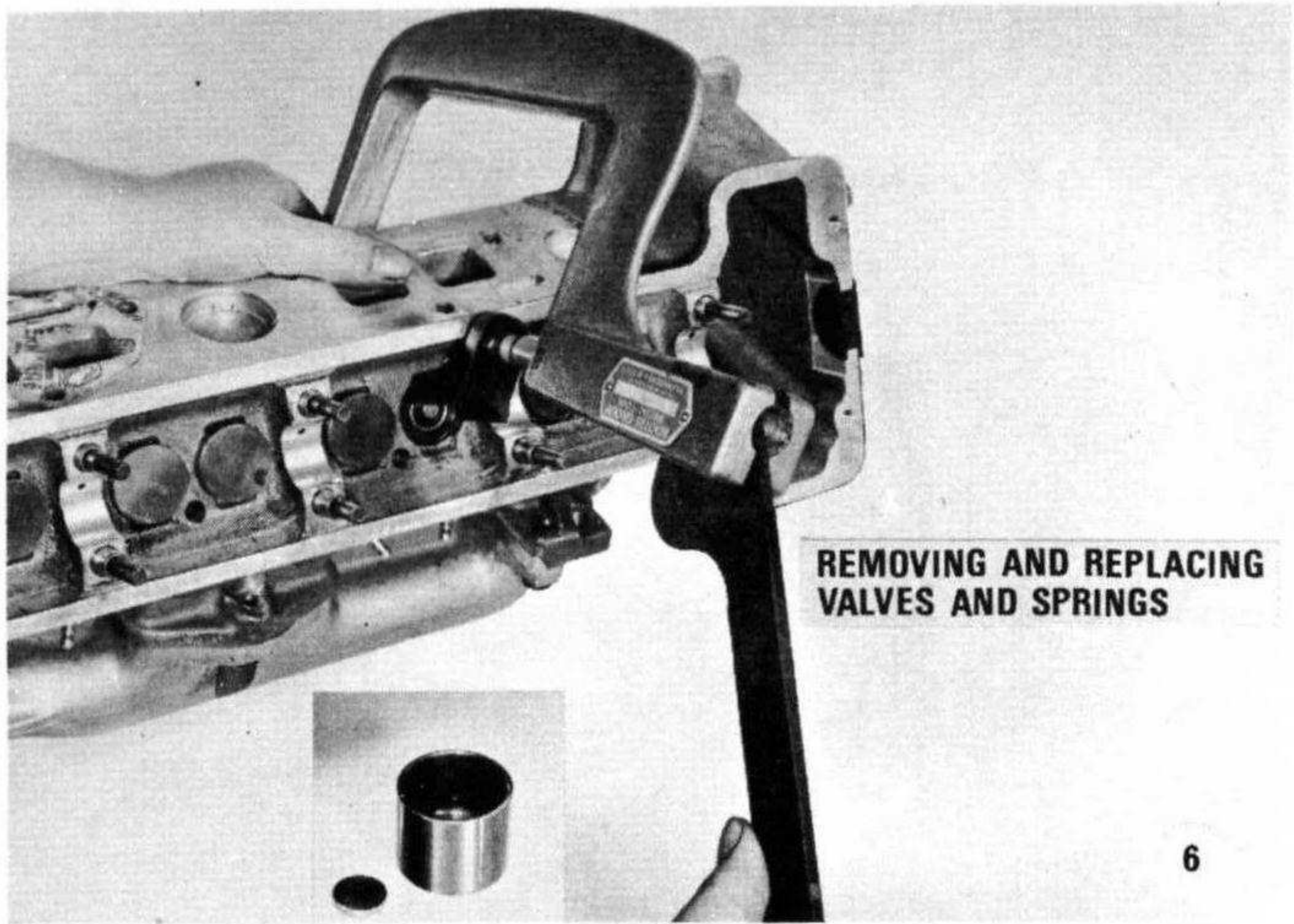

FRAME 6

VALVE REMOVAL

Remove each valve and spring using tool No. 18G 106 (RG 6513) and adaptor S 352.

Remove the cotters, top cup, spring, bottom cup and valve.

NOTE: The inlet and exhaust valve springs are identical and should be fitted with the close coil to the bottom.

Refitting is the reverse of the removal procedure.

Ensure the spring and cotters are fully seated.

CORRECTLY SEATED VALVE

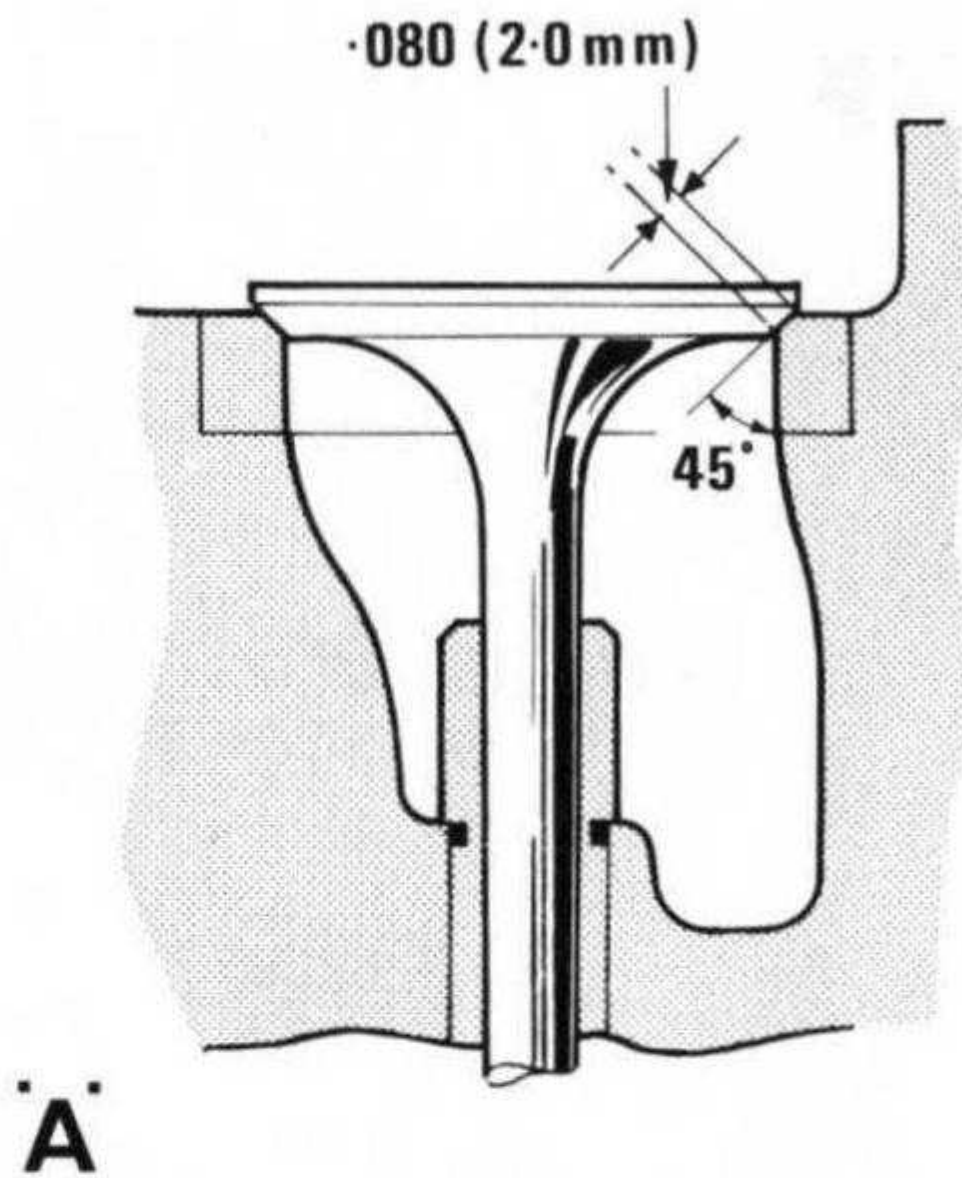

SEAT WIDTH REDUCING CUTTER

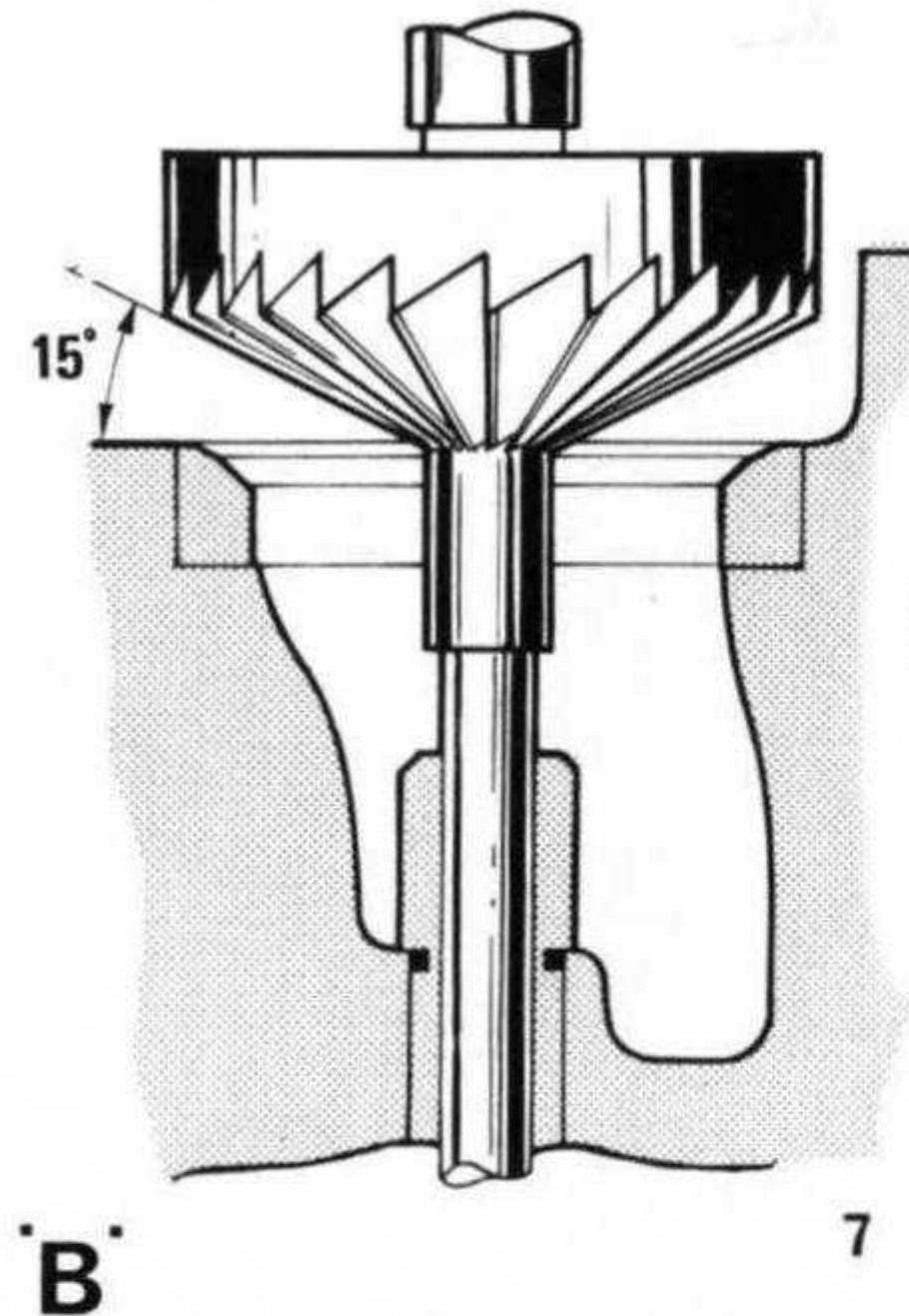

FRAME 7

VALVES

Before starting to grind valves it is most important that all valves are numbered so that they are kept to their respective valve seats.

1. Clean all valves and seats.
2. Inspect valves for bent stems, eccentricity of head, and pock-marks.
3. Inspect valve seats for pocketing, pock-marks, cracks, and distortion.
4. If there are deep pock-marks in the valve seats, deglaze and re-cut seat to 45° before grinding in valves.

Illustration 'A' shows a correctly seating valve.

Illustration 'B' shows a 15° cutter used to reduce the width of the valve seat.

VALVE GUIDE REMOVAL

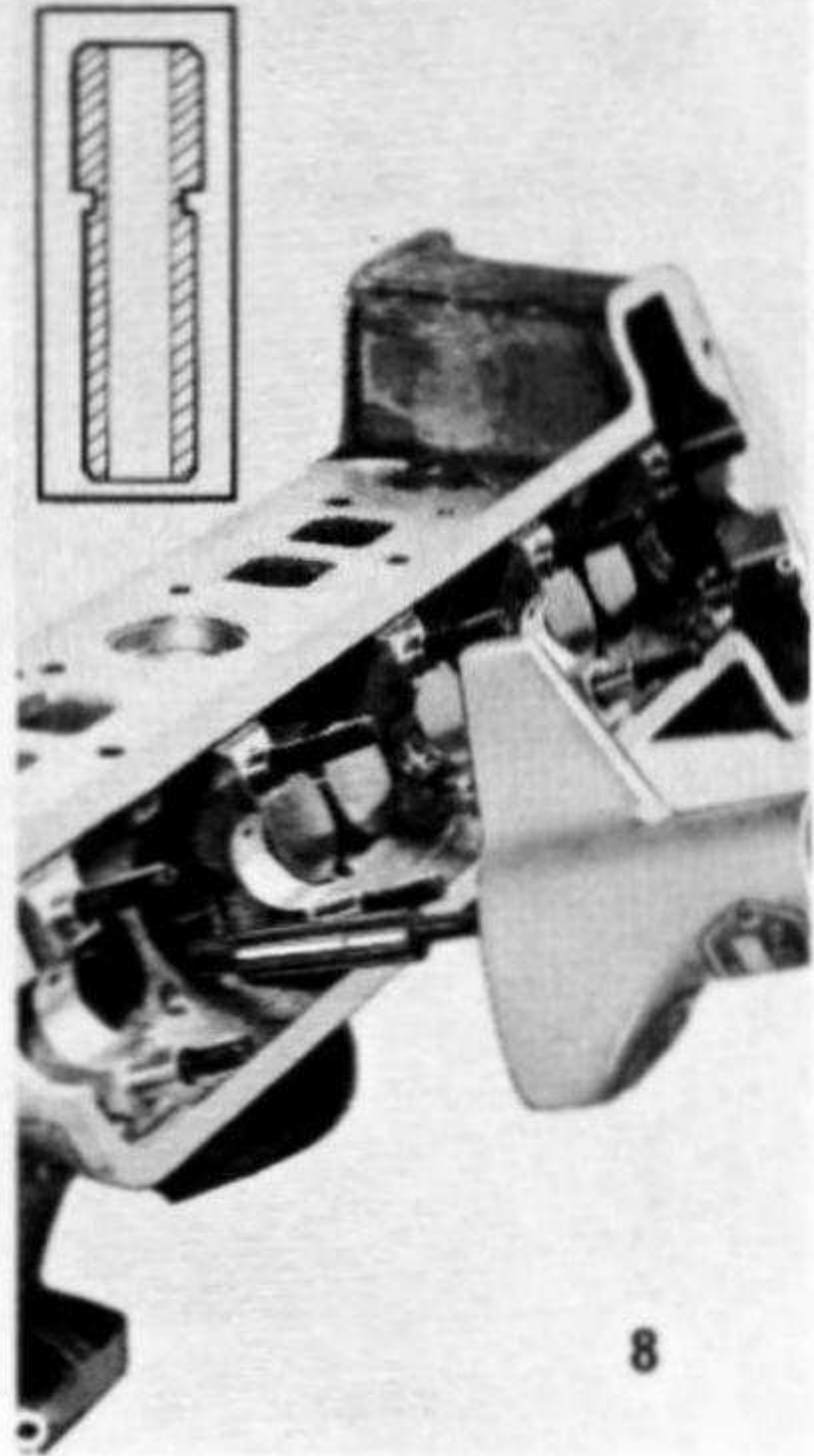
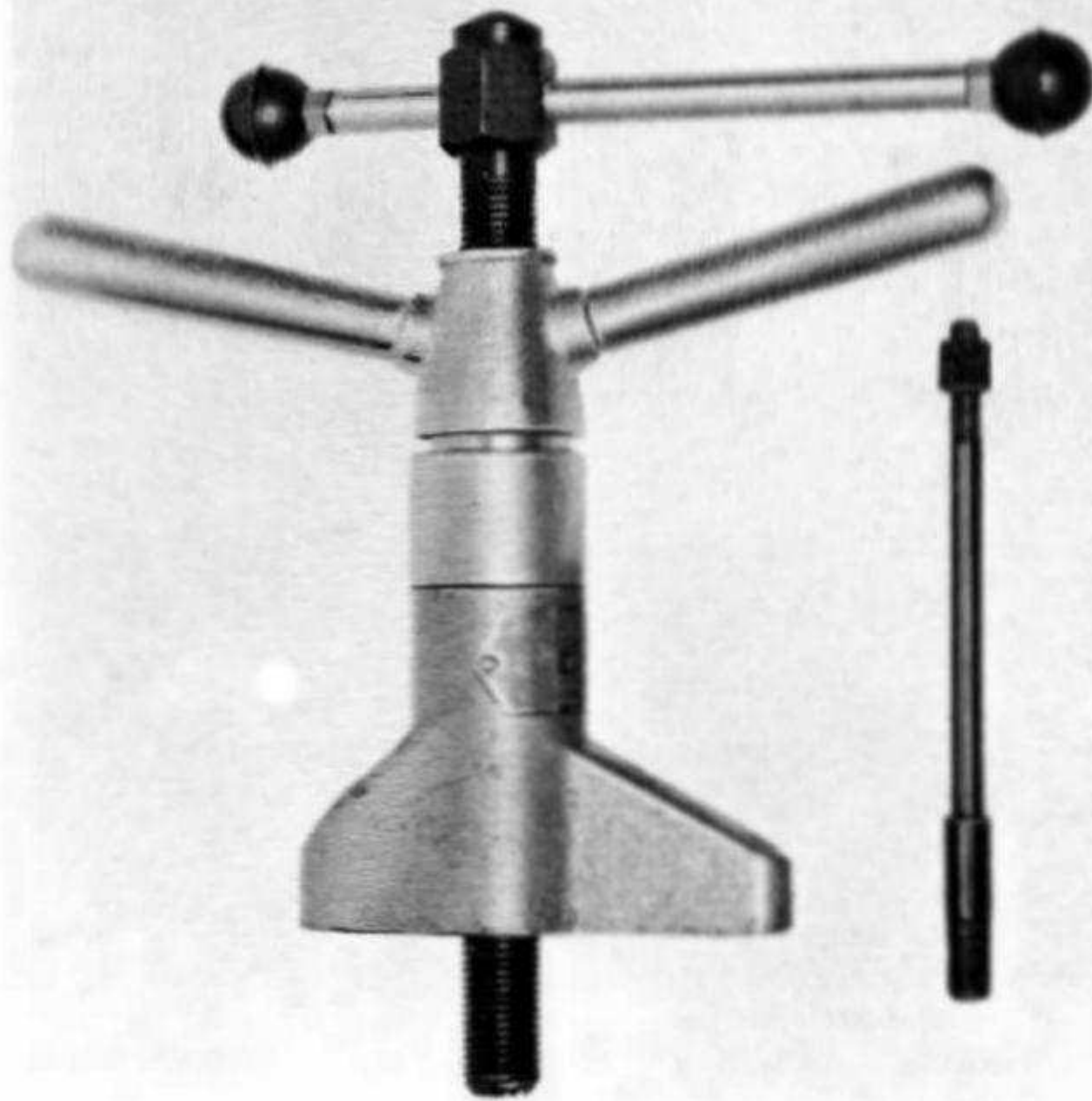

FRAME 8

VALVE GUIDES

The inlet and exhaust valve guides are identical. A step is machined onto the guide as shown in the inset of the illustration.

Use special tool No. 60A as shown in illustration and withdraw the valve guide from the head.

NOTE: DO NOT heat the cylinder head to aid extraction of valve guides.

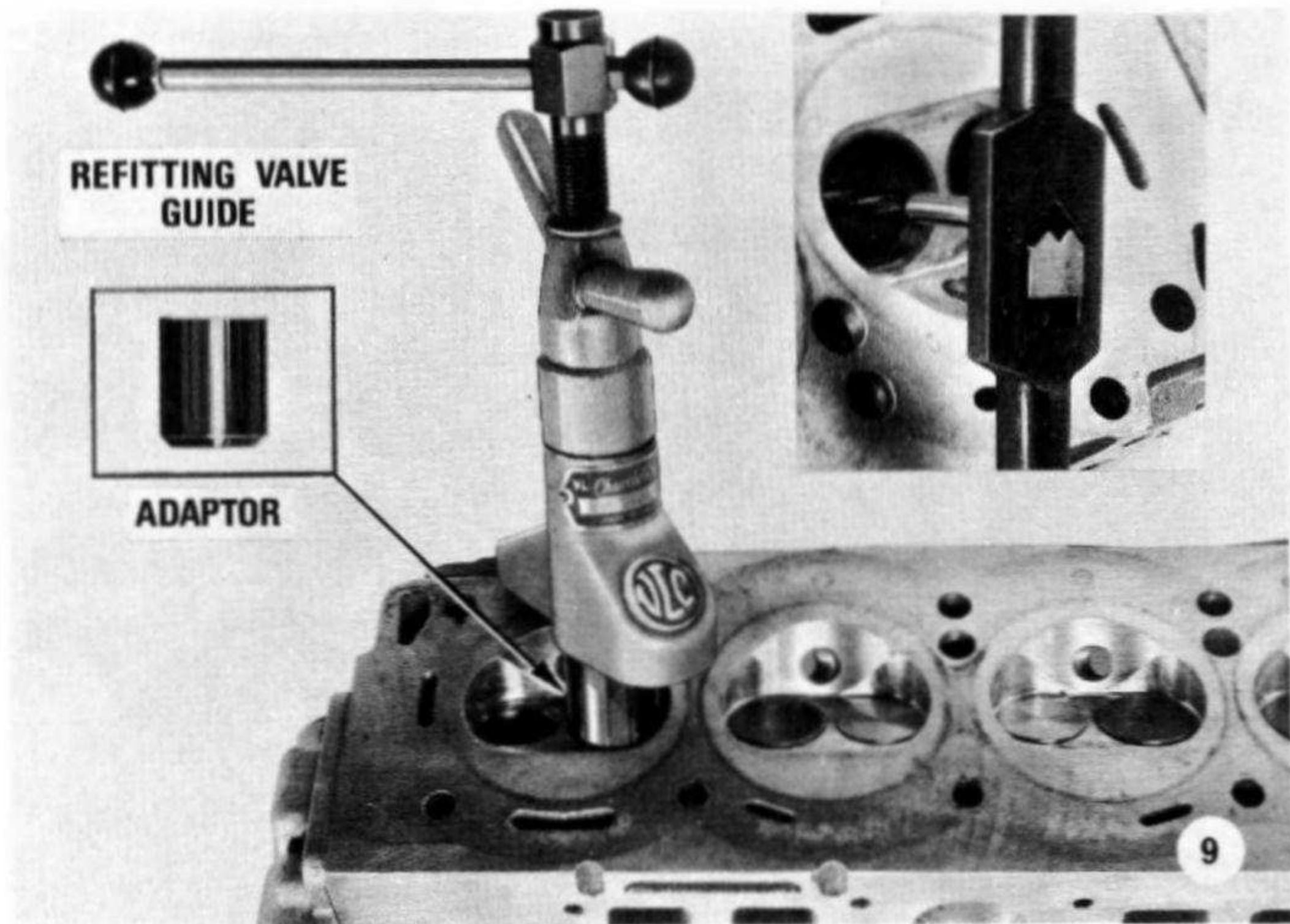

FRAME 9

VALVE GUIDE REFITTING

DO NOT replace the original valve guides. Replacement valve guides must be 0.002" (0.05 mm.) oversize.

Using adaptor 60A8 as shown, pull the valve guide into position after applying graphite to the guide and head.

Pull the guide into position to the machined step.

Ream the valve guides using a $\frac{5}{16}$ " (7.9 mm.) reamer.

NOTE: It is essential after fitting new valve guides to re-cut the valve seats.

CHECKING TAPPET CLEARANCES

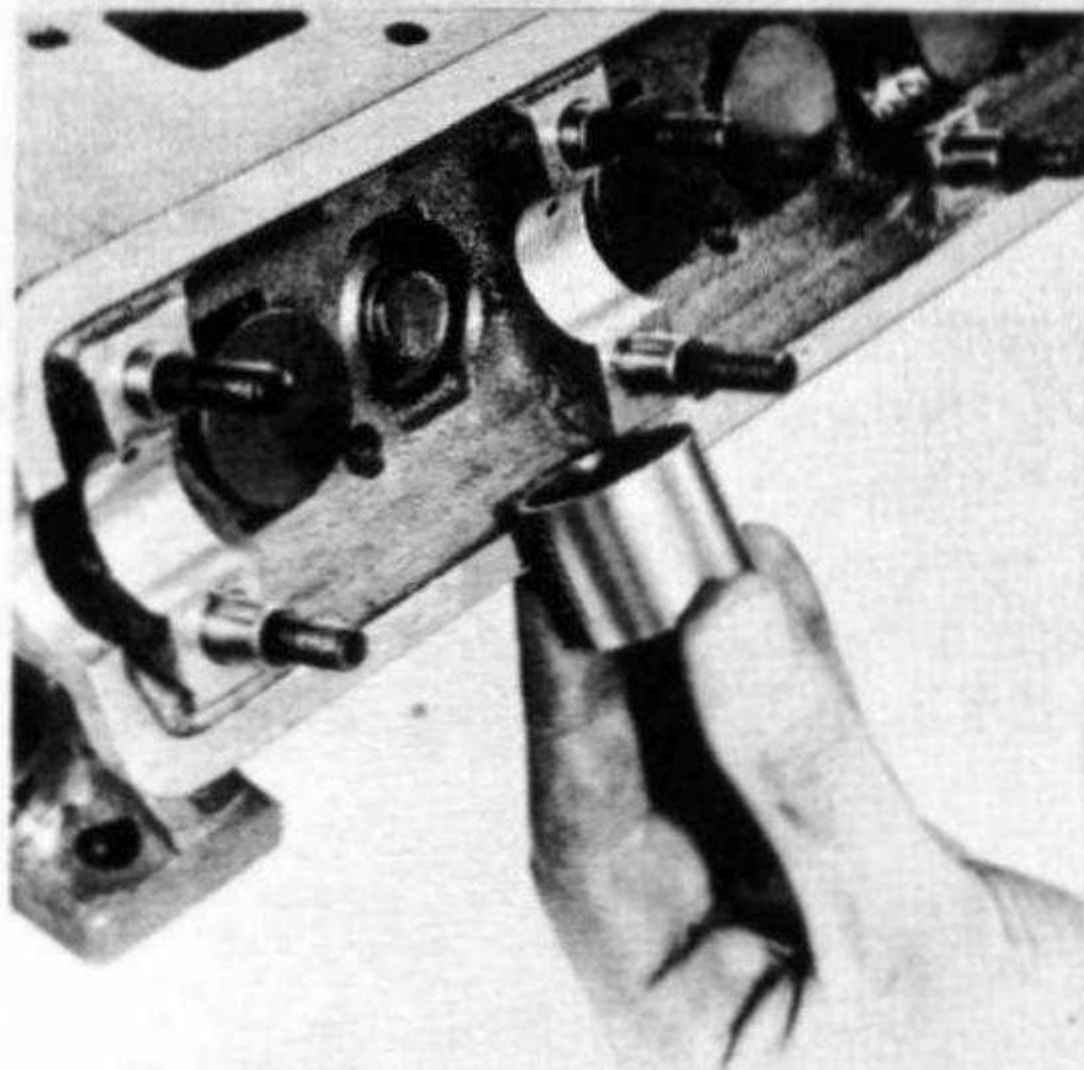

**PALLET IN POSITION
AND TAPPET BEING
REFITTED**

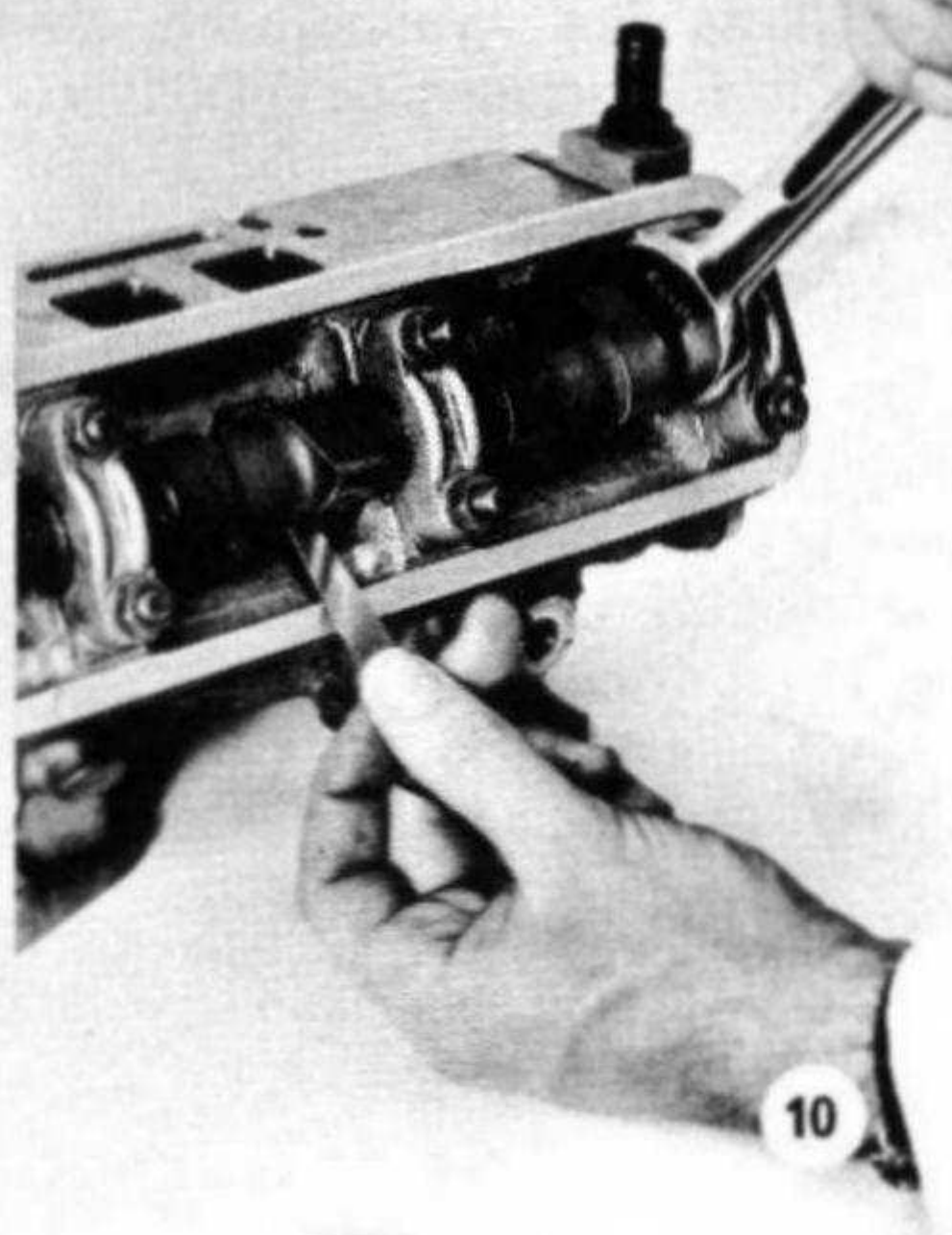

FRAME 10

TAPPET ADJUSTMENT

Clean all oil from tappets and adjustment pallets.

Refit complete set of pallets and tappets in their original positions.

Place camshaft in position and fit numbered camshaft bearing caps.

Turn cylinder head onto exhaust flange to avoid damage to valves.

Tighten camshaft bearing cap nuts progressively to 12–14 lb. ft. (1.7–1.9 kg. m.).

Using a spanner on the cast hexagon at the rear of camshaft to rotate the cams, and using feeler gauges, check the clearance between the cam base and tappet as shown.

Clearances: INLET 0.006"–0.008" (0.15–0.20 mm.)

EXHAUST 0.016"–0.018" (0.4–0.45 mm.)

Note readings obtained on all tappets and if not within tolerance given remove camshaft as described and alter pallets to suit.

The pallets are available in sizes from 0.070"–0.114" (1.7–2.9 mm.) thickness in increments of 0.001" (0.02 mm.).

EXAMPLE

If reading obtained on an INLET tappet is 0.012" (0.3 mm.), a pallet of **increased** thickness (i.e. 0.003" (0.07 mm.)) must be fitted to give correct clearance of 0.008"–0.010" (0.2–0.25 mm.).

When tappet clearances are correct, remove camshaft, tappets and pallets and thoroughly oil all components before refitting camshaft and tightening bearing caps nuts to correct torque 12–14 lb. ft. (1.7–1.9 kg. m.).

REFITTING CAMSHAFT COVER

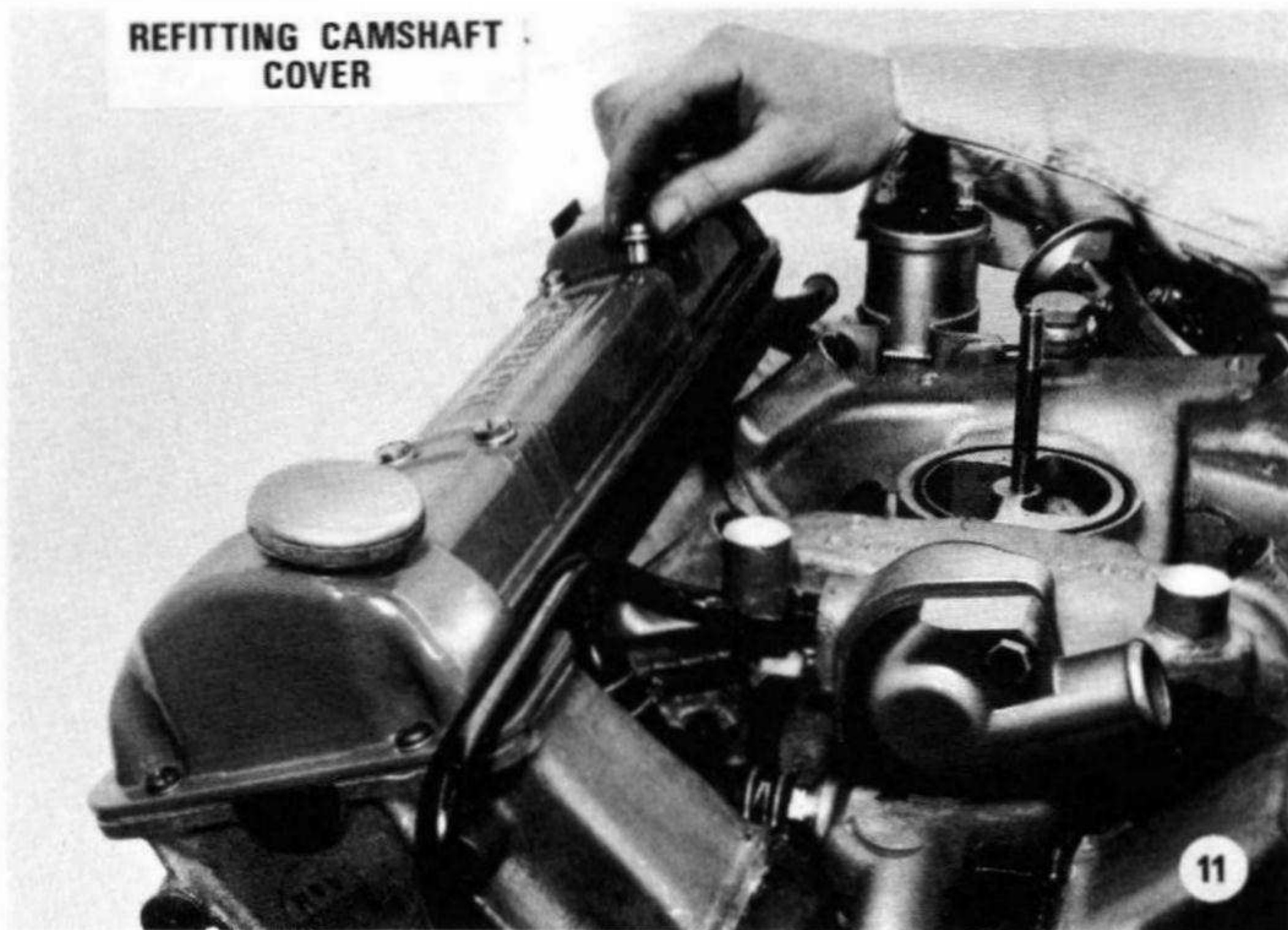

FRAME .11

CAMSHAFT COVERS

Refer to either page 50 or 55 for appropriate camshaft refitting instructions.

Fit bolts securing chain sprockets to camshafts.

NOTE: DO NOT rotate engine with cylinder heads in position and camshaft chain sprockets disconnected.

Rotate engine until the two remaining sprocket to camshaft securing bolts can be fitted. Tighten to 7–9 lb. ft. (0.9–1.2 kg. m.) and knock over tab washers.

Replace the two rubber plugs on each cylinder head.

Fit cork gaskets and replace the camshaft covers and secure with four special screws.

Fit two screws and washers securing front of each camshaft cover to the cylinder head.

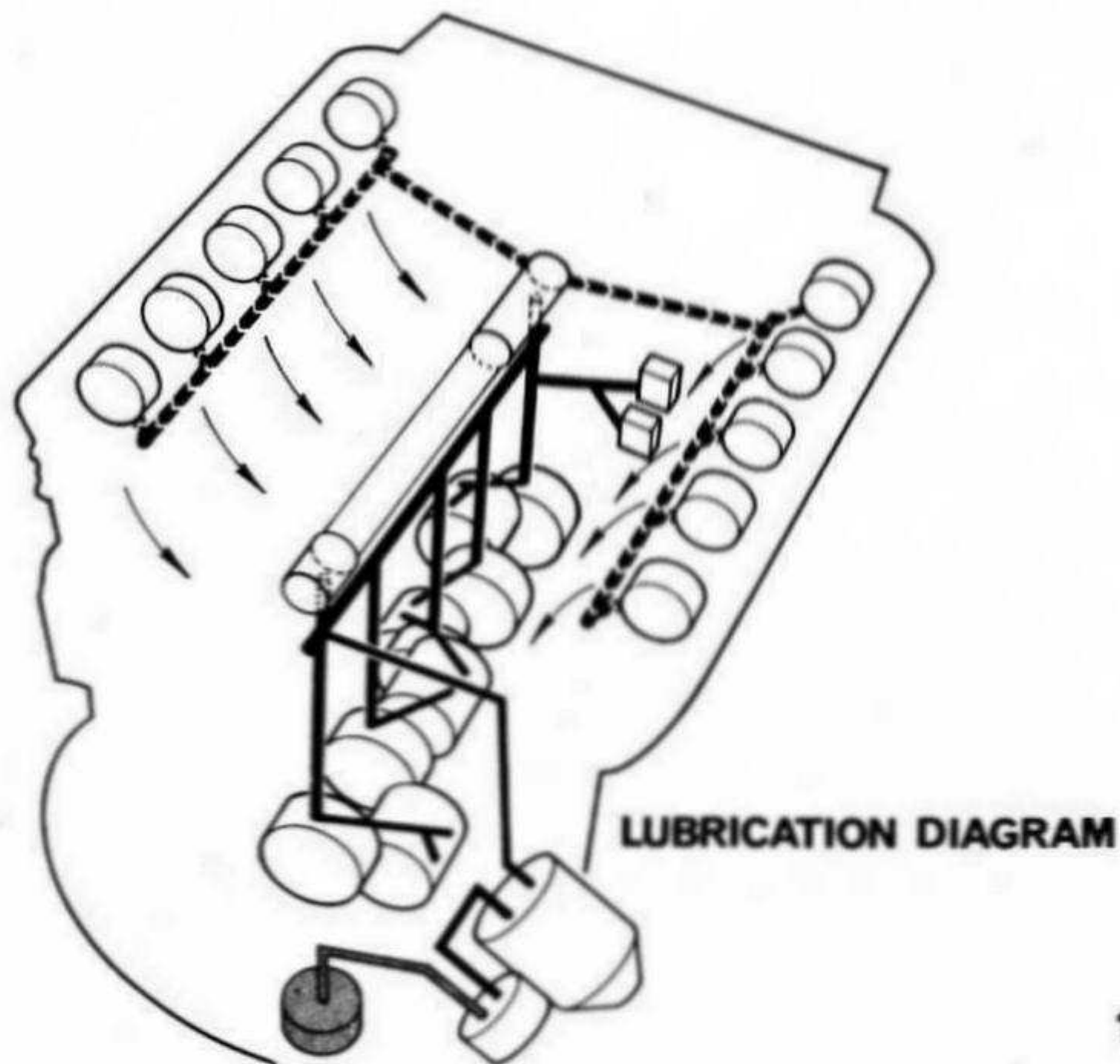

FRAME 12

PART 2

LUBRICATION

The engine is fitted with a wet sump system.

The rotor-type oil pump is driven by the idler shaft via the distributor gear.

Oil is drawn from the sump through a wire filter to the pump and pressure relief valve.

Oil then passes through an external full-flow element type filter and then to the main oil gallery via the transfer port.

From the main gallery oil is distributed to all bearings and moving parts.

Oil is fed to the camshafts from an intermittent feed on the idler shaft front bearing.

Drain holes in the heads and idler shaft tunnel allow oil to return to the sump.

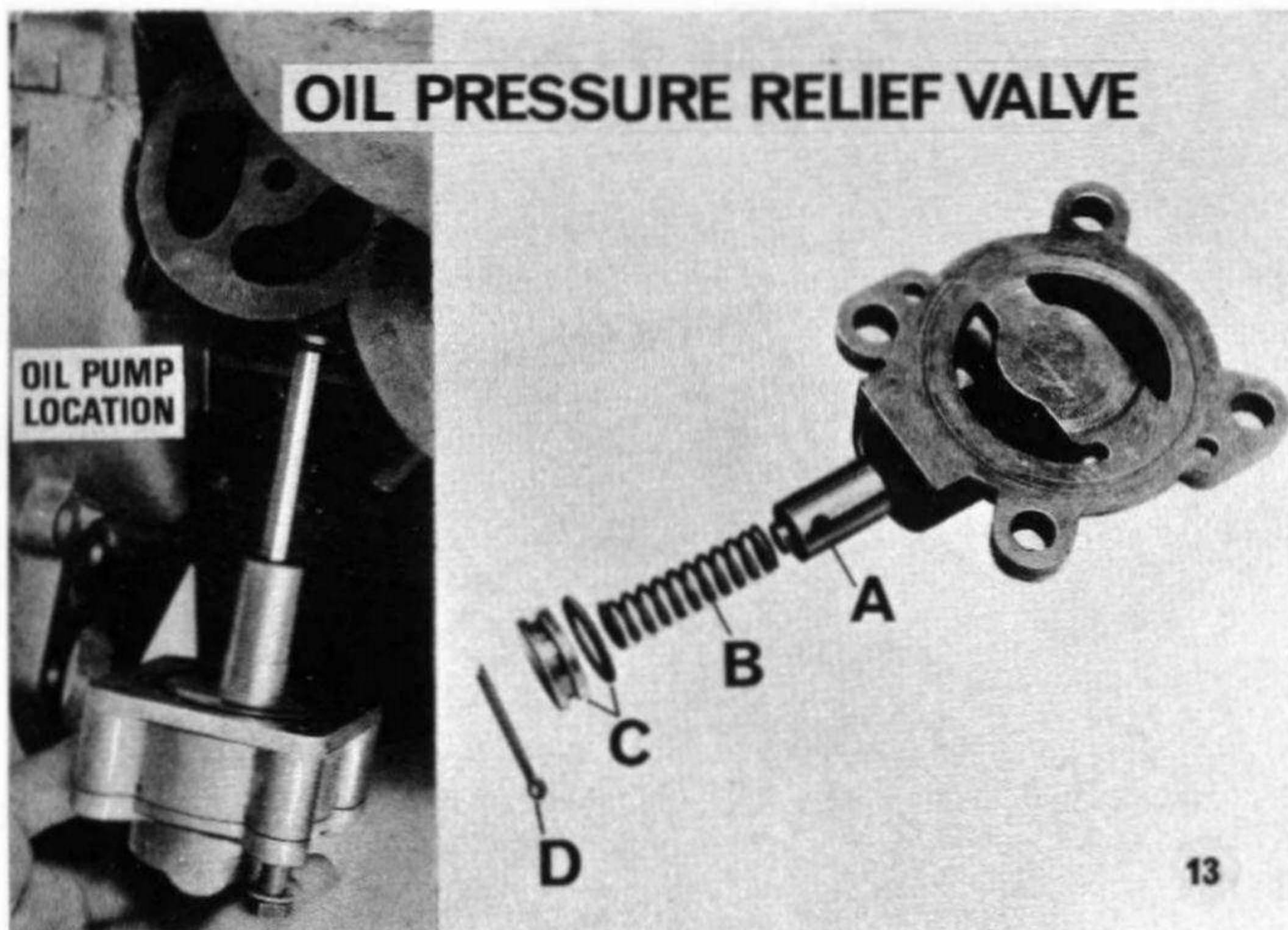

FRAME 13

OIL PUMP

An external oil pump secured to the crankcase by four bolts and washers tightened to 16–20 lb. ft. (2.2–2.8 kg. m.). The oil pump is driven by the idler shaft via the distributor.

An 'O' ring provides a seal between the pump and block.

The oil pressure with the engine at correct running temperature should be 55–55 lb./sq. in (3.5–3.8 kg./sq. cm.).

An oil pressure relief valve is fitted integral with the oil pump base plate and consists of:

- A. Relief valve
- B. Spring
- C. Spring location plug and 'O' ring
- D. Split pin securing relief valve to assembly.

CHECKING CLEARANCE ON
OIL PUMP ROTOR



FRAME 15

Clearance between the inner and outer rotors is very important and must not exceed 0.010" (0.25 mm.).

OIL PUMP

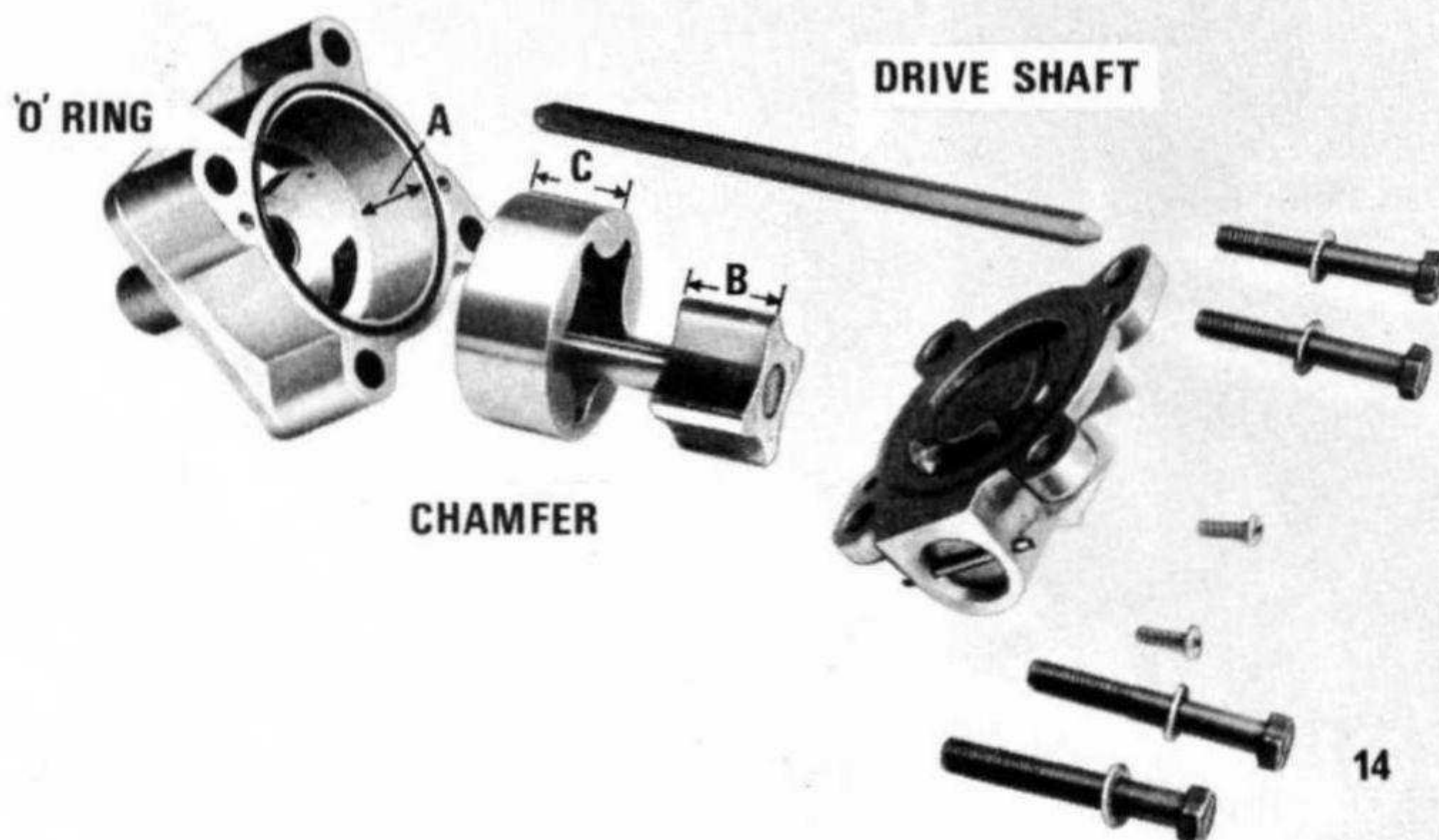

FRAME 14

The oil pump consists of an inner and outer rotor. The following points should be checked during overhaul.

- (a) Inner and outer rotors when assembled in the pump body must not exceed 0.004" (0.10 mm.) end-float.
- (b) The end plate must be perfectly flat and free of scores.
- (c) The clearance between outer rotor and pump body must not exceed 0.008" (0.20 mm.).

NOTE: The chamfer on outer rotor is innermost.

OIL FILTER ASSEMBLY

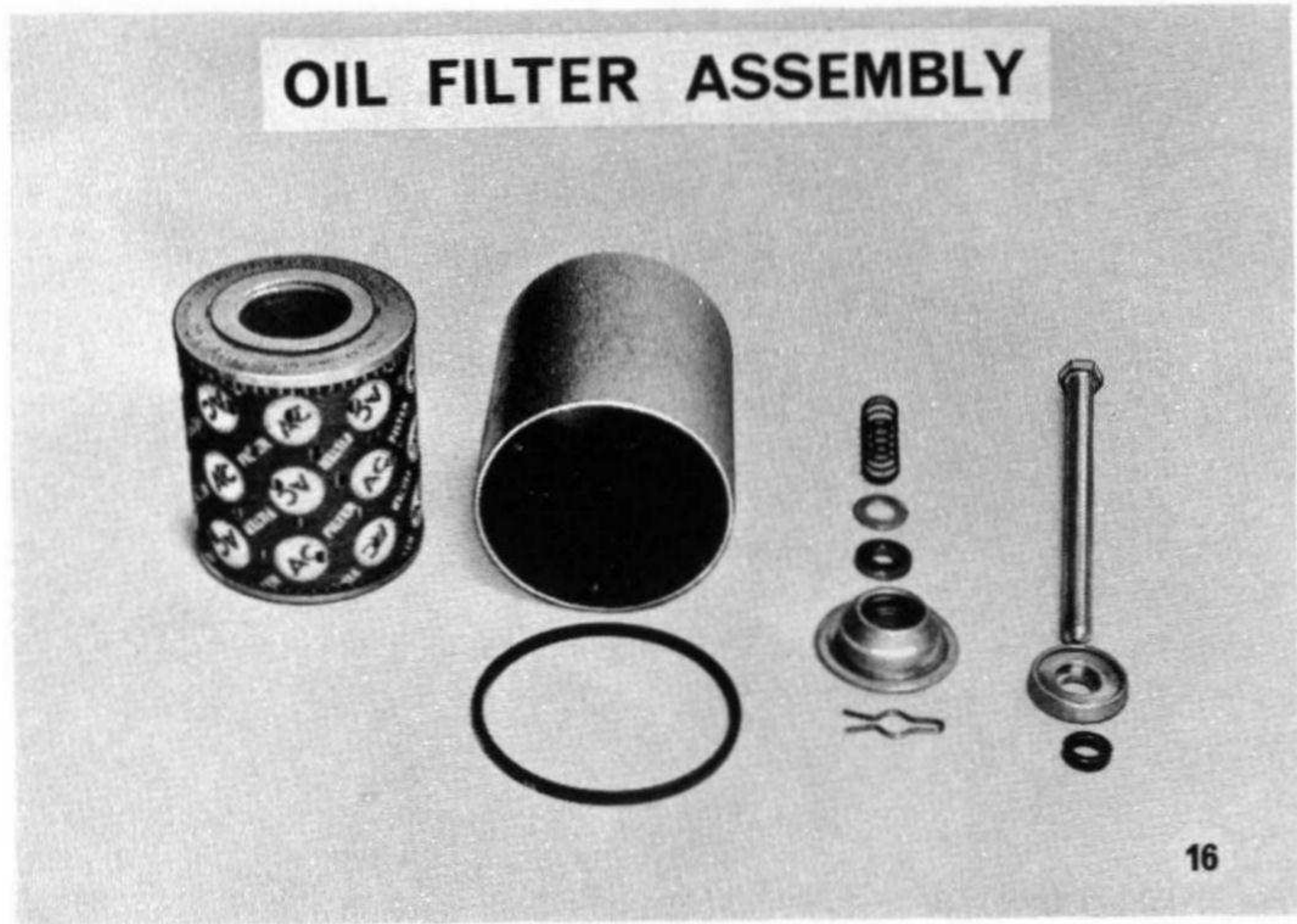

FRAME 16

OIL FILTER

The oil filter is of the full-flow type fitted with a paper element, which must be changed at regular intervals according to operational conditions.

The filter body is secured to the side of the cylinder block by a central bolt. Oil sealing between filter body and crankcase is by a rubber ring.

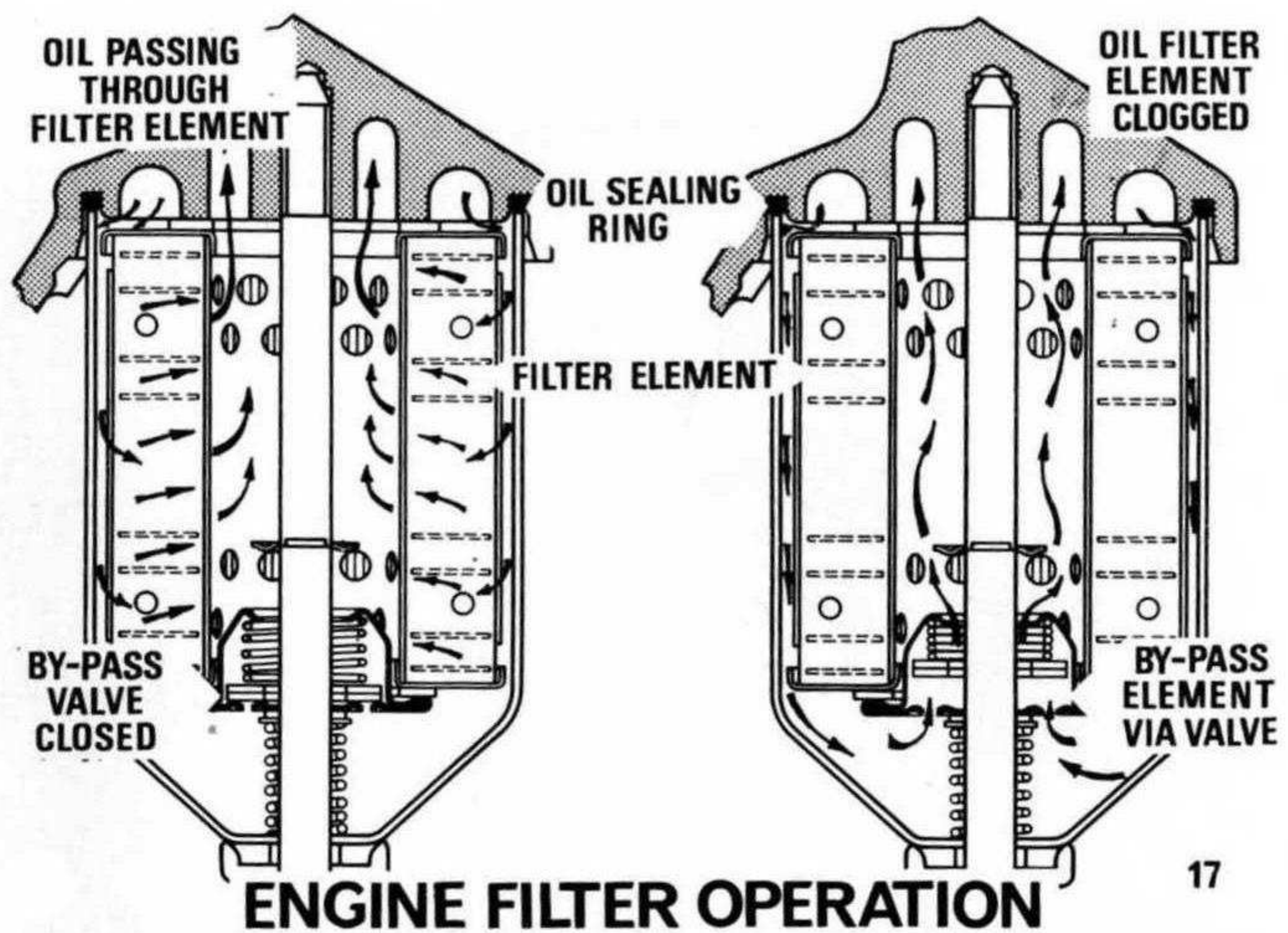

FRAME 17

The left-hand diagram shows how the oil passes through the filter element to the main oil gallery.

The right-hand diagram shows what happens to the oil if the filter element becomes blocked.

The oil by-passes the element via a spring-loaded valve.

This safety valve is essential to prevent starvation of oil to the bearings.



FRAME 18

OIL TRANSFER HOUSING

The housing is secured to the block by a single bolt and washer and is sealed by two 'O' rings.

Tighten bolt to 26–32 lb. ft. (3.6–4.4 kg. m.).

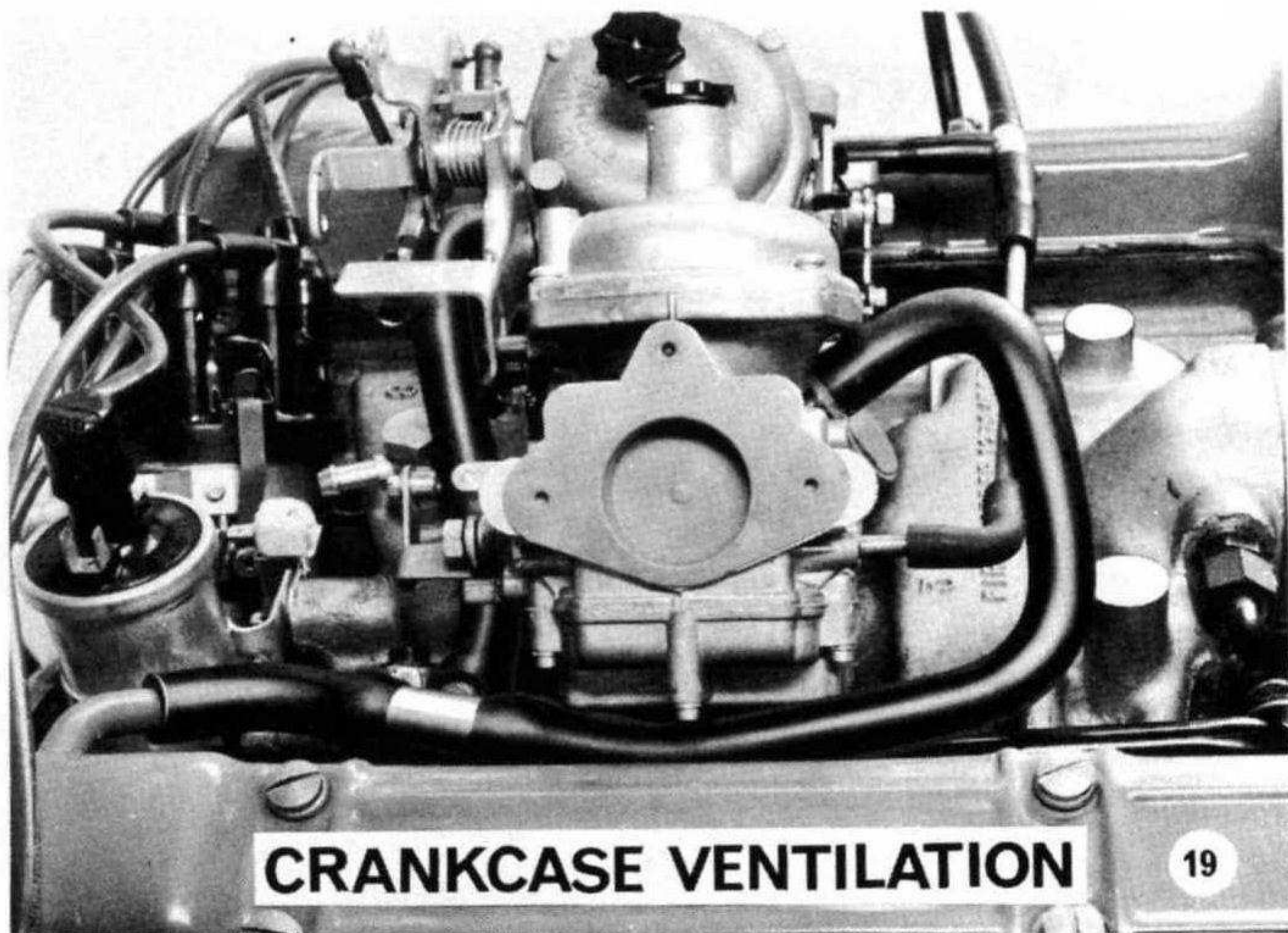

FRAME 19

PART 3

CRANKCASE VENTILATION

On the right-hand camshaft cover a gauze filter is fitted integral with the cover.

A rubber pipe from the gauze filter is connected to the constant depression side of the carburettors.

Every 12,000 miles (20000 km.) clean the right-hand camshaft cover gauze filter and pipe with methylated spirits (denatured alcohol). Ensure the breather pipes are clean and serviceable. If excessive contamination is apparent in the system it will be necessary to dismantle the carburettors and clean the air valve and body.

A shield is shown on the carburettor flange, to prevent foreign matter entering the carburettor during assembly. This is, of course, removed before the air cleaner elbows are fitted.

CRANKSHAFT ASSEMBLY

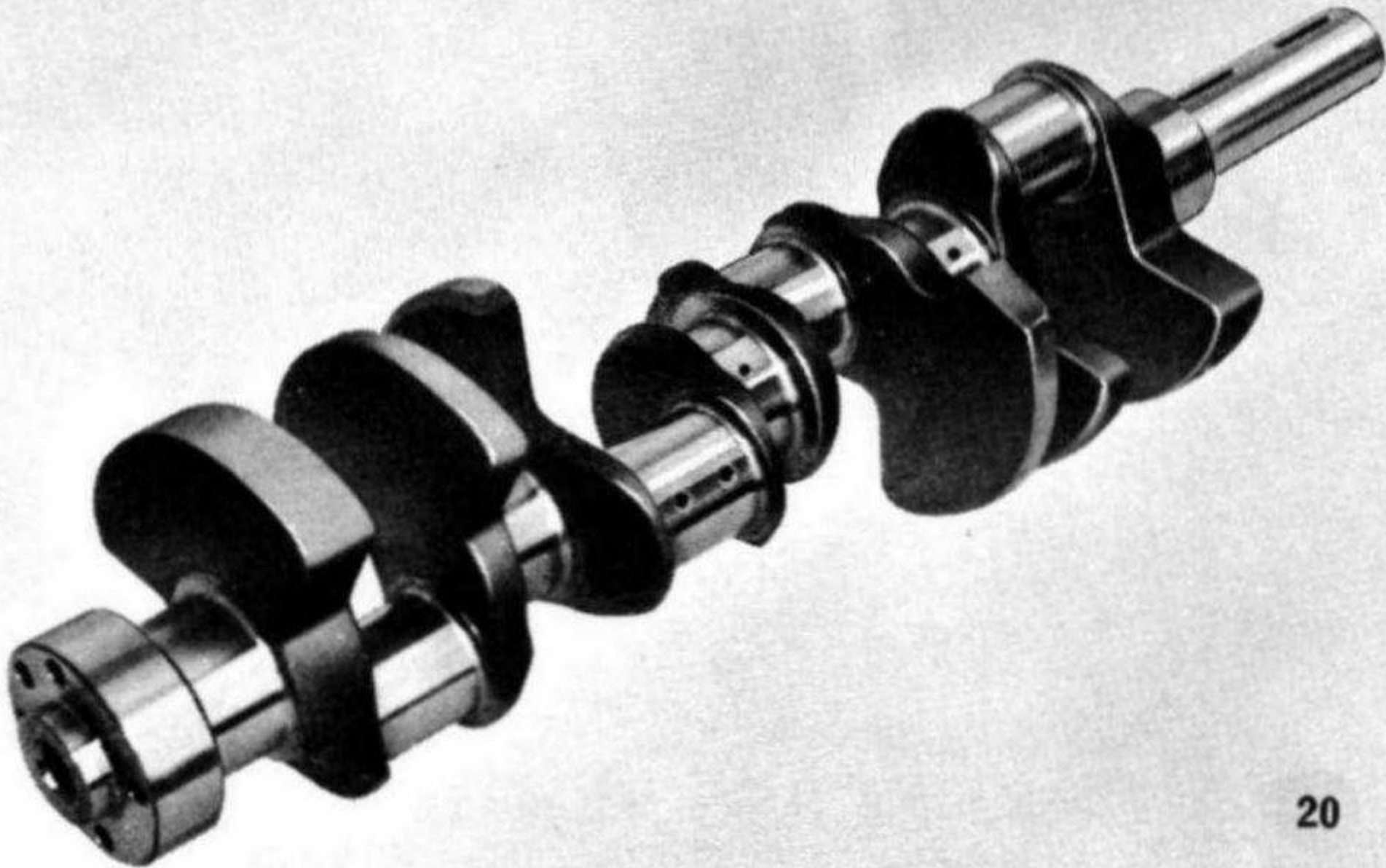

FRAME 20

PART 4

CRANKSHAFT AND ASSEMBLIES

The four-throw crankshaft is counterbalanced and has five main bearings.

Drillings through the crank pins to communicate with the main journals form an integral part of the lubrication system.

When overhauling the engine, check taper and ovality of crankpins and main journals which must not exceed 0.002" (0.05 mm.).

If the crankshaft requires regrinding, check with manufacturer for safe working limits.

MAIN BEARING

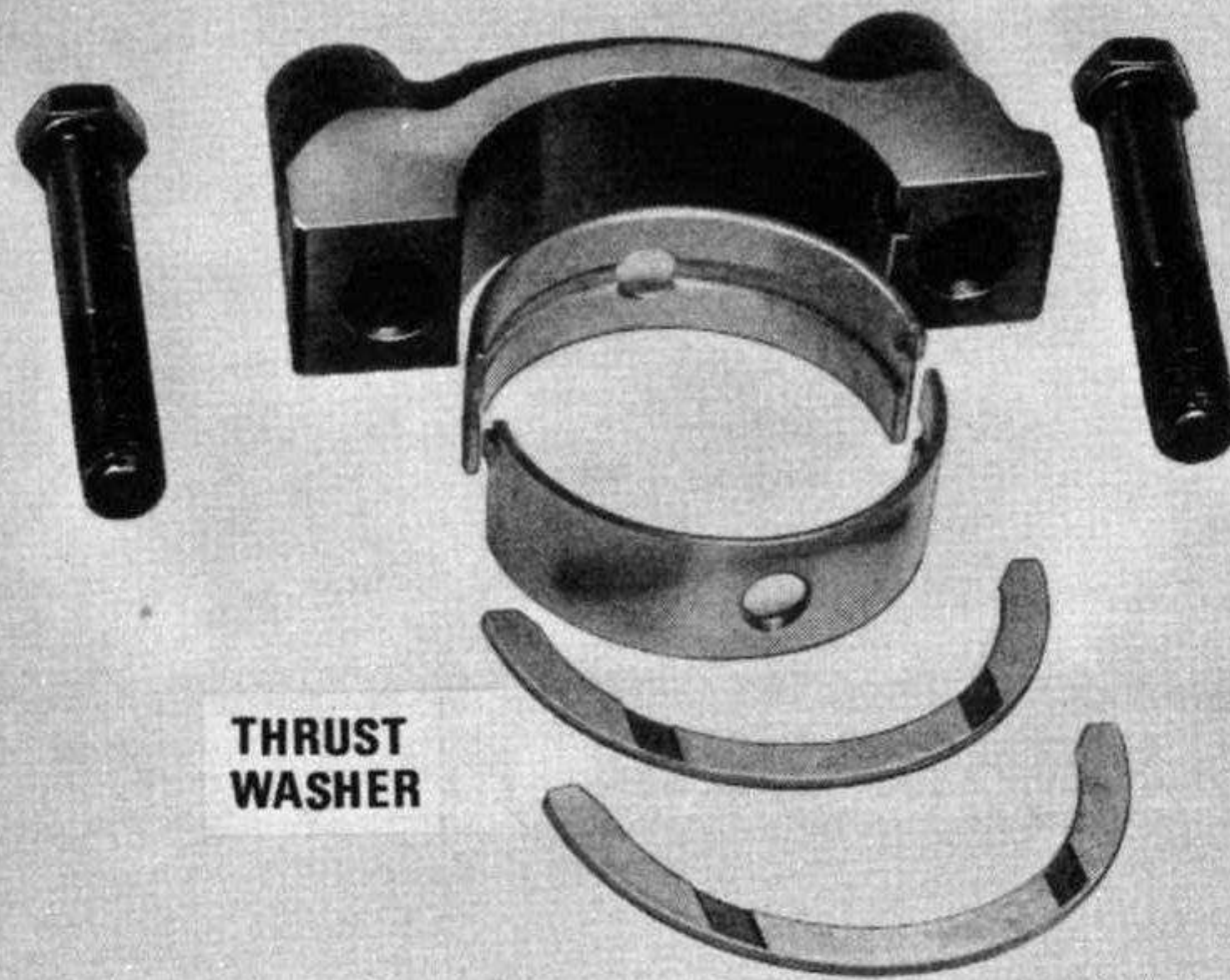

THRUST
WASHER

21

FRAME 21

Crankshaft end-float is controlled by thrust washers on either side of the crankcase half of the centre main bearing.

When fitted, the centre main bearing cap overlaps the thrust washers and prevents them rotating.

The bearing surface and sludge grooves on the thrust washers should be fitted to face the crankshaft.

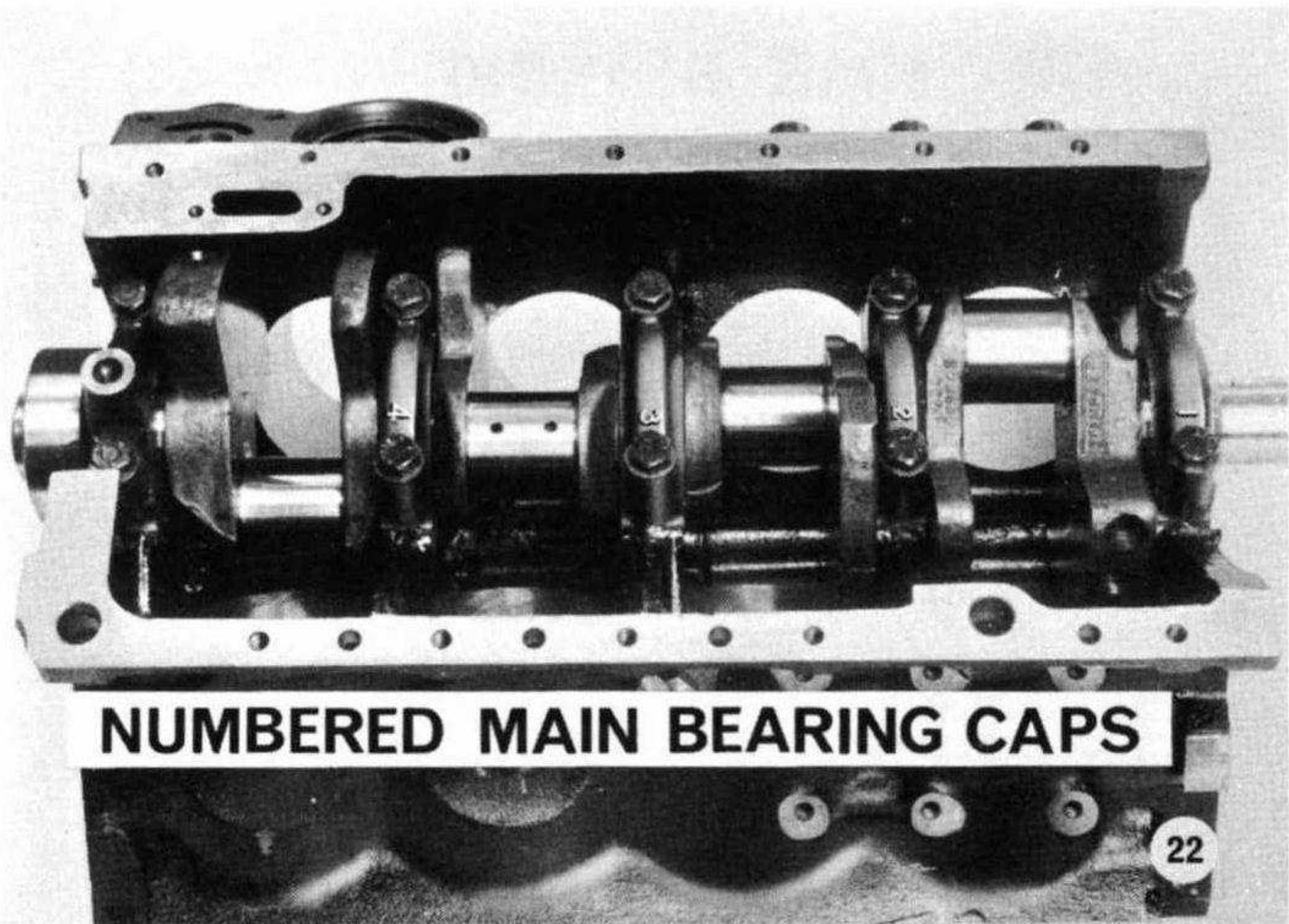

FRAME 22

CRANKCASE ASSEMBLY

The crankshaft is supported in five main bearings of the steel-backed shell type. The bearing material is phosphor bronze overlaid with lead-indium.

Before assembly, thoroughly clean all parts and inspect for defects. Re-assemble the crankshaft following the procedure given below.

NOTE: Nos. 2 and 4 main bearing shells are smaller in width.

1. Fit main bearing shells to the crankcase and smear with oil.
2. Fit crankshaft and slide crankshaft thrust washers into position on either side of the centre main journal.

NOTE: Bearing material towards crankshaft.

3. Fit bearing shells into main bearing caps and smear with oil.
4. Fit all main bearing caps, with the numbers cast on top of caps in their correct order and facing away from the oil filter, No. 1 at the front of crankcase.

The main bearing cap numbers are also cast into the webs on the crankcase.

NOTE: No. 5 main bearing cap is not numbered but has a boss cast on the top.

5. Tighten the ten crankshaft main bearing cap bolts progressively to 55–60 lb. ft. (7.6–8.3 kg. m.).
Check crankshaft for free rotation.

CRANKSHAFT END FLOAT

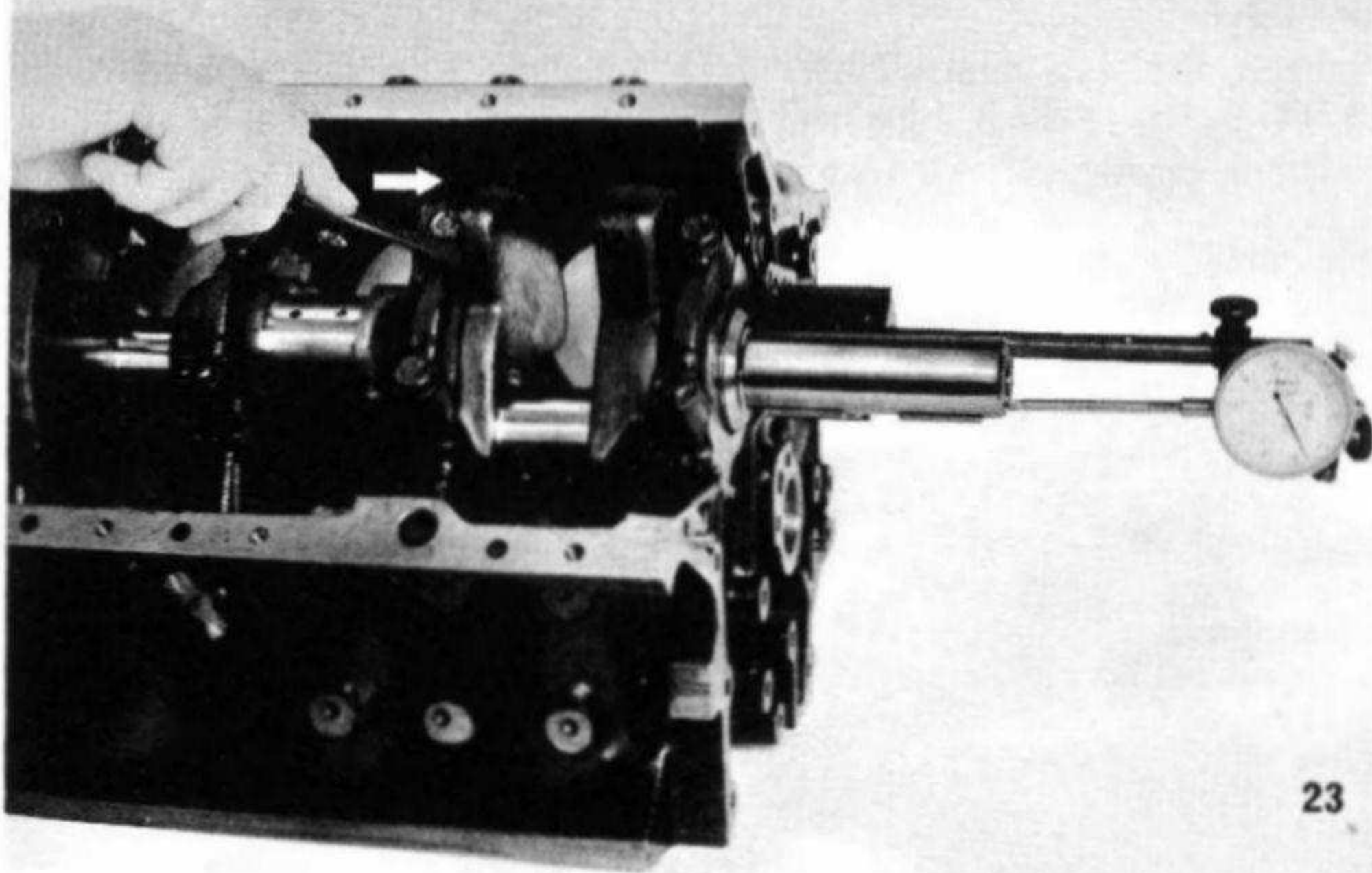

FRAME 23

To check the crankshaft end float the following procedure should be followed.

1. Make sure all main bearing caps are tightened to the correct torque, 55–60 lb. ft. (7.6–8.3 kg. m.).
2. Force the crankshaft away from the main bearing thrust washer and with a dial indicator as shown check that the end-float is within limits of 0.003–0.011" (0.07–0.28 mm.).

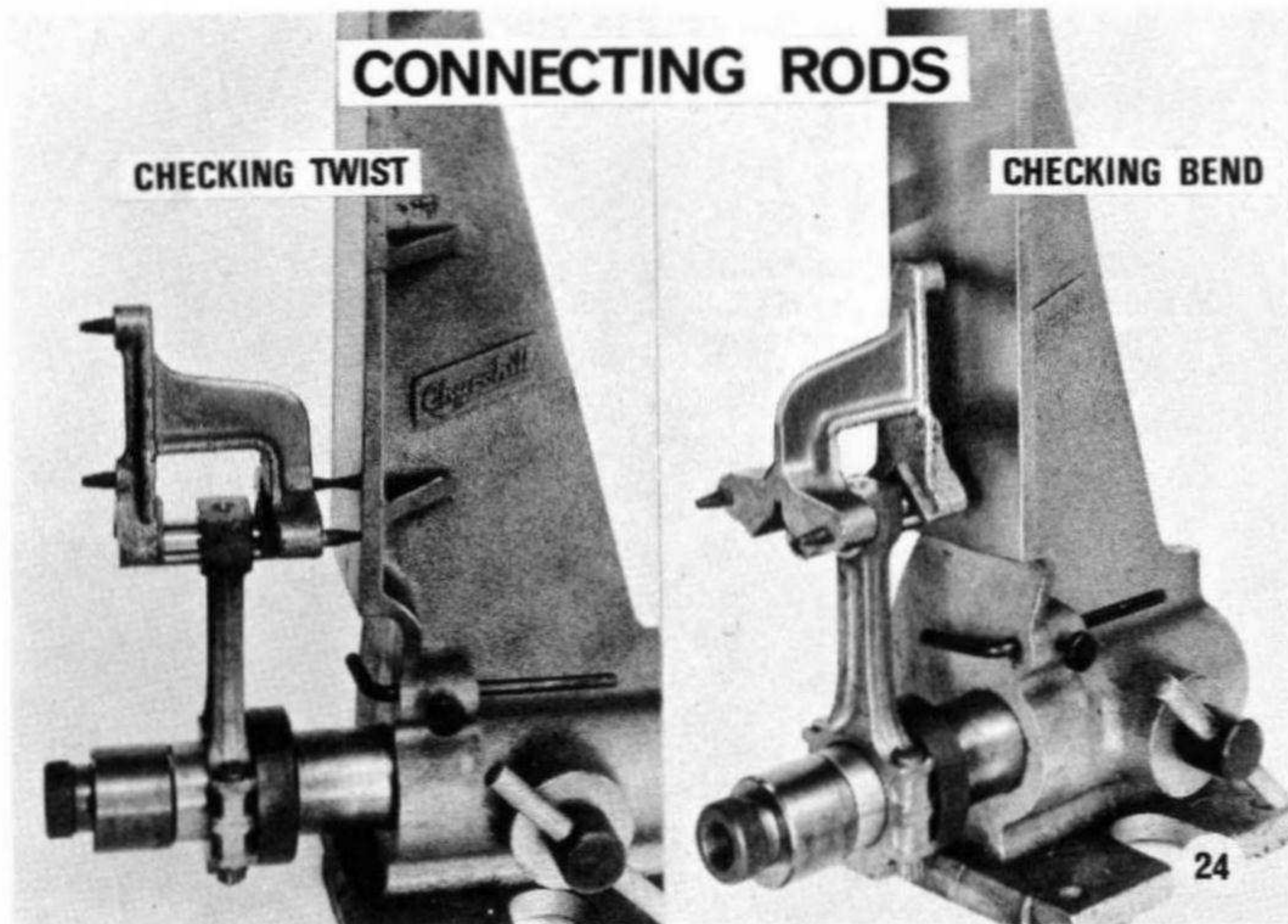

FRAME 24

CONNECTING RODS AND PISTONS

To check the connecting rods for distortion a jig as shown should be used in conjunction with tool No. 336/3, arbor adaptor.

The right-hand illustration shows the fixture set for checking BEND.

The left-hand illustration shows the fixture set for checking TWIST.

The amount of error is indicated by malalignment of the 'V' block pegs in relation to the machined face.

The amount of BEND must not exceed 0.0015" (0.038 mm.) for length of gudgeon pin.

The amount of TWIST must not exceed 0.0015" (0.038 mm.) per inch length of gudgeon pin., e.g. 0.006" (0.15 mm.) for 3" (7.62 cm.) length.

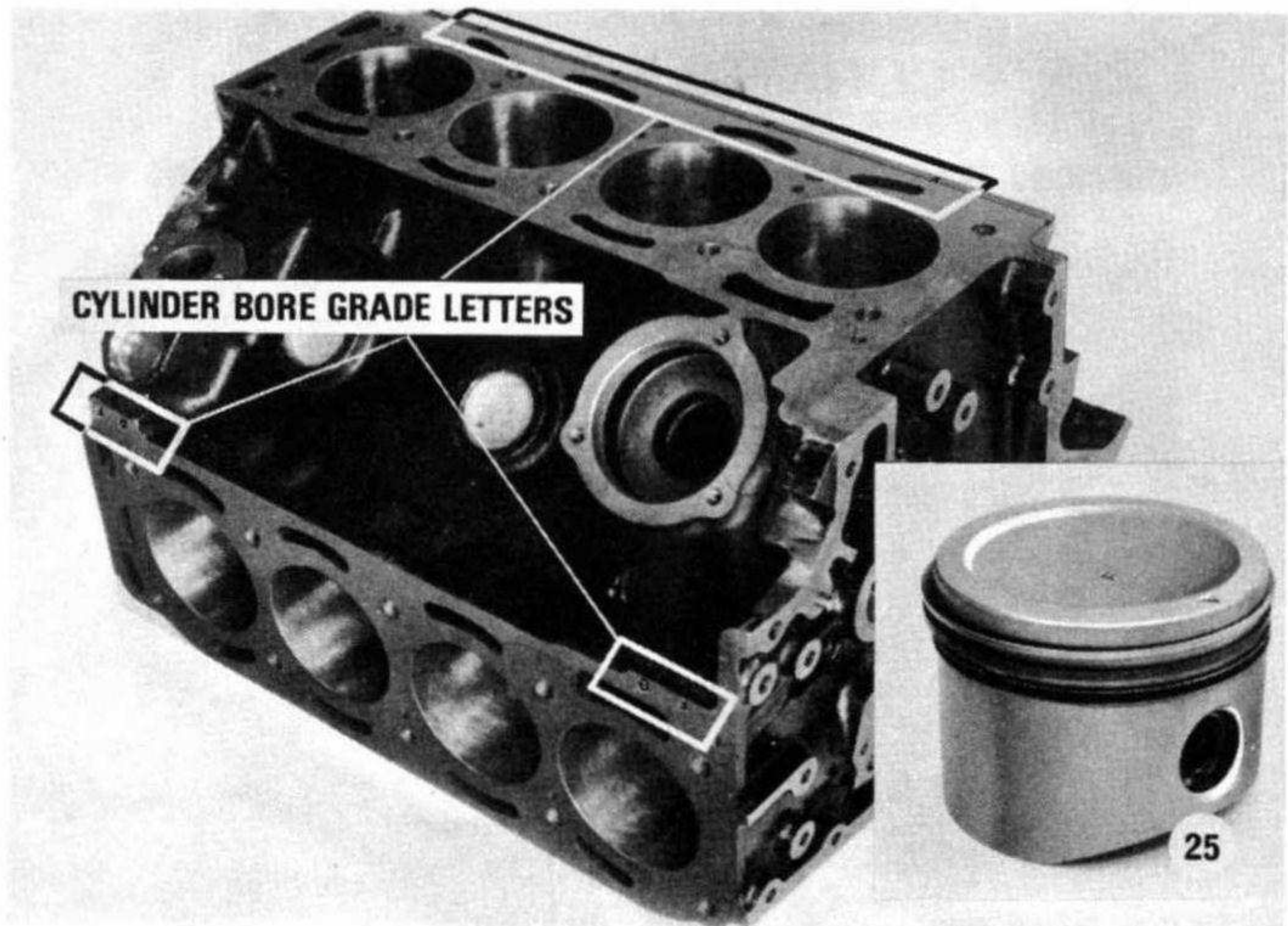

FRAME 25

To simplify the process of assembly the pistons and cylinder bores are graded for size. The difference between each grade is 0.0005" (0.012 mm.).

CYLINDER BLOCK

The piston grading letters are stamped onto the cylinder block in the position shown in the illustration.

PISTONS

The piston grade is stamped onto the crown of the piston and the front denoted by a triangle.

When the cylinders have been re-bored the grade letters no longer have any meaning.

PISTON RINGS

- No. 1 Compression
- No. 2 Scraper—Stepped ring top face marked 'TOP'.
- No. 3 Scraper—Spring oil control.

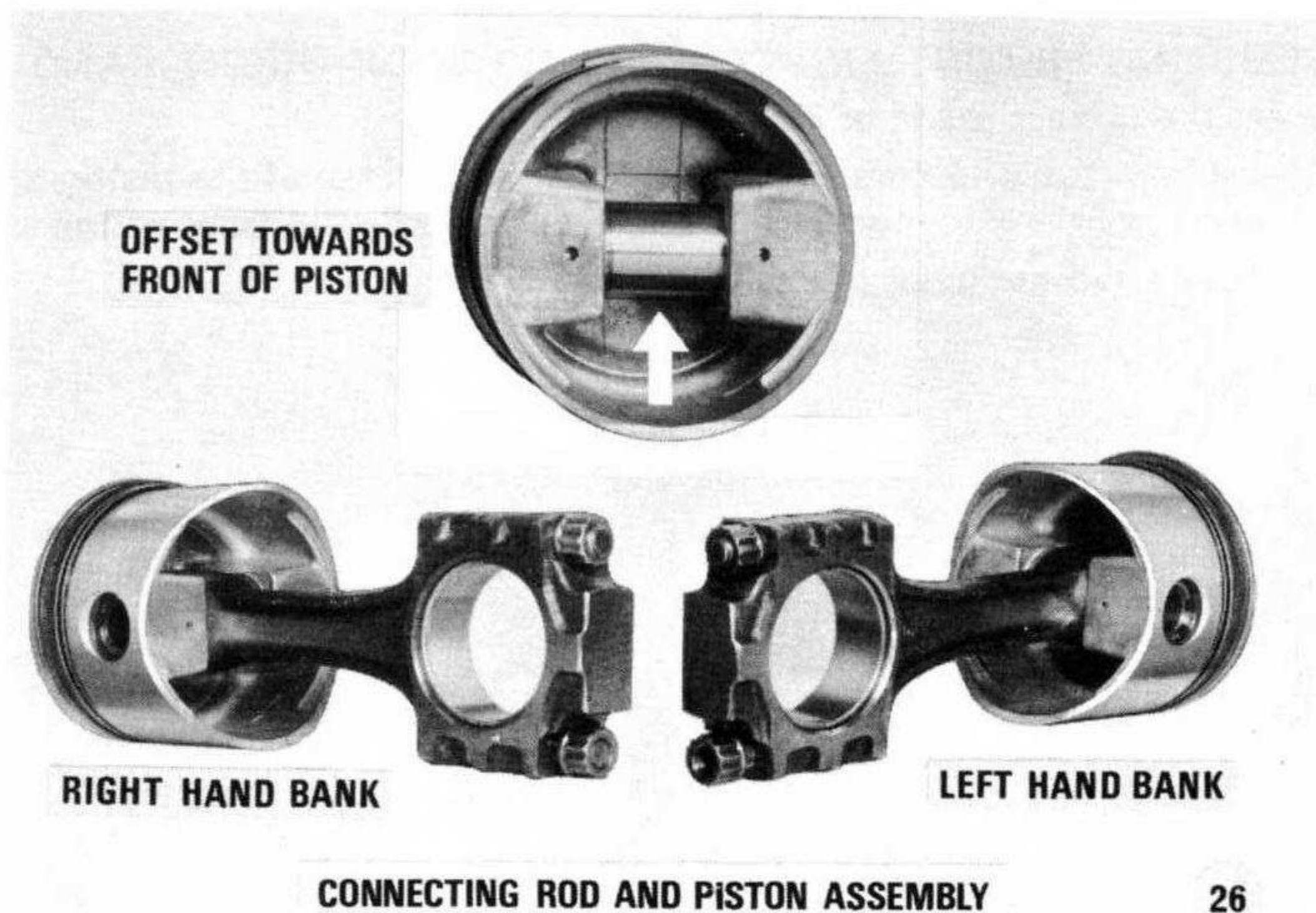

FRAME 26.

CONNECTING RODS AND PISTONS

The connecting rods are 'I'-section steel forgings.

The pistons are fitted with gudgeon pins of the fully-floating type which are located laterally by circlips.

The connecting rod little-end should be reamed and the gudgeon pin is fitted using thumb pressure.

ASSEMBLING PISTONS AND CONNECTING RODS—LEFT-HAND BANK

Select the correct grade of piston.

Assemble piston and connecting rod so that the front of the piston is towards the front of the engine and the chamfer on the connecting rod big-end faces the rear of the crank.

Fit one circlip to the recess in the piston.

Apply oil to the little-end bush. With the connecting rod held in position press in gudgeon pin and secure with remaining circlip.

ASSEMBLING PISTONS AND CONNECTING RODS—RIGHT-HAND BANK

Select the correct grade of piston.

Assemble piston and connecting rod so that the front of the piston and the chamfer on the connecting rod big-end face towards the front of the engine.

Fit circlips and gudgeon pin as described.

ASSEMBLING PISTON AND CONNECTING RODS

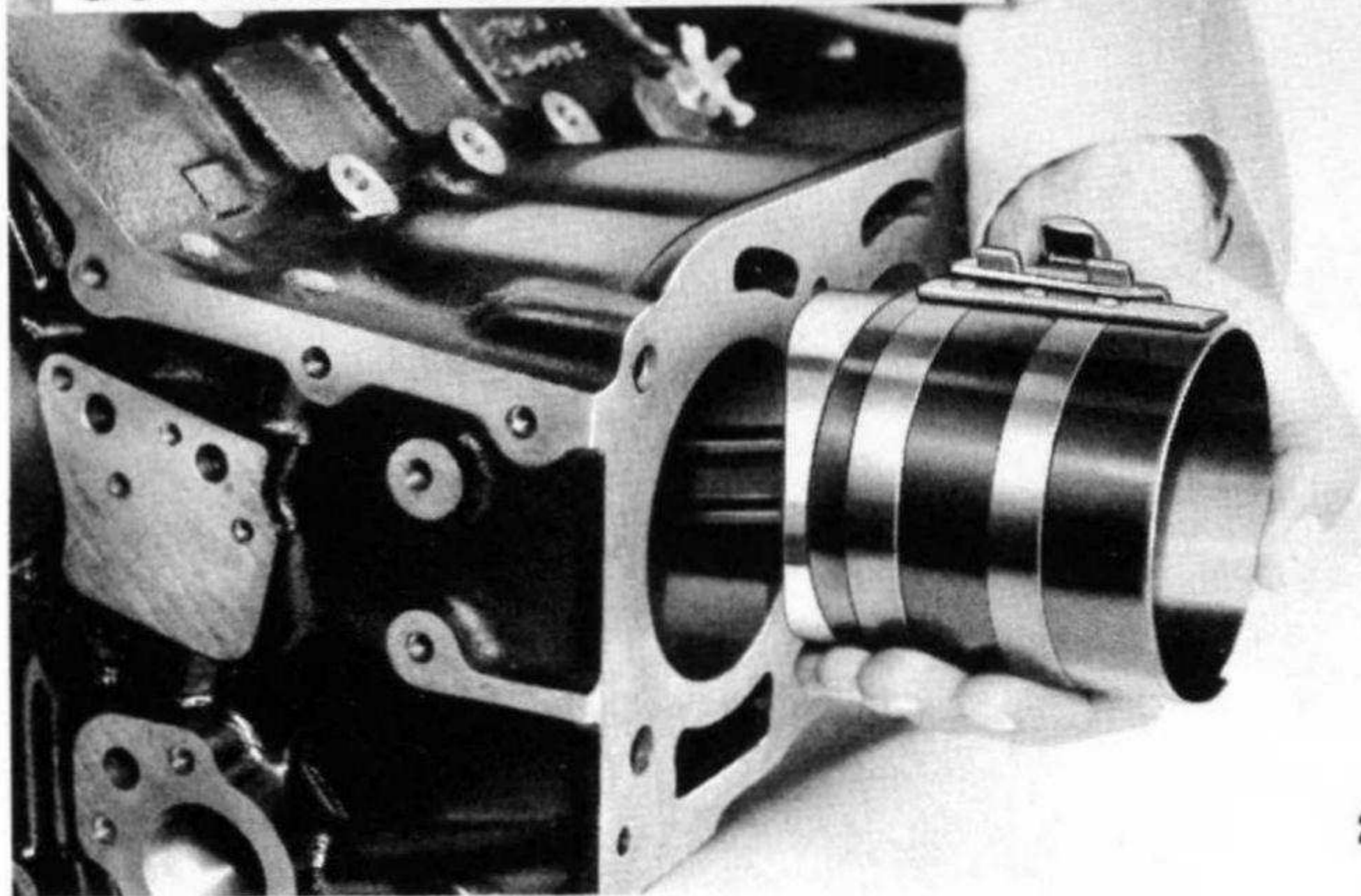

27

FRAME 27

FITTING THE PISTONS

The piston and connecting rod assembly is installed from the top of the cylinder block using the following procedure.

1. Space the piston ring gaps evenly round the piston ensuring there are no gaps on the thrust side.
2. Lubricate the pistons and rings thoroughly.
3. Fit piston ring clamp to piston.
4. Feed piston and connecting rod assembly into bore of cylinder block.
NOTE: Care being taken that piston mark is facing front of engine.
5. Fit bearing shells to connecting rod big-end and lubricate bearings.
NOTE: Connecting rod big-end caps stamped 1–8 consecutively from the front of crankshaft.
6. Ensure bearing caps are fitted with corresponding numbers together.
7. Fit big-end bearing caps and tighten nuts to 38–42 lb. ft. (5.25–5.8 kg. m.).

CHECKING END-FLOAT BETWEEN BIG END BEARINGS

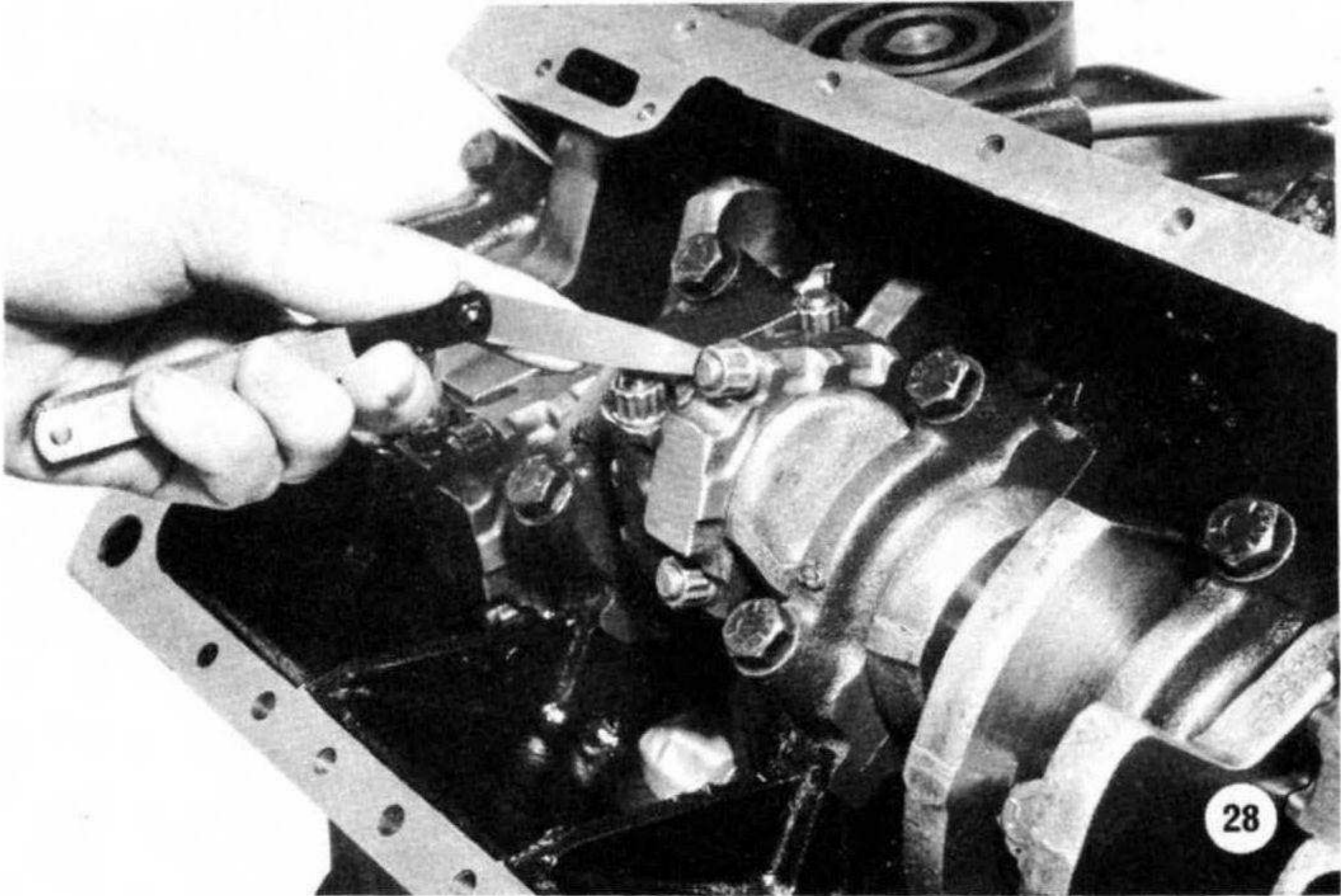

FRAME 28

CHECKING END-FLOAT BETWEEN CONNECTING ROD BIG-ENDS

Check the end-float between the connecting rods on each crank journal using feeler gauges. This clearance should be between 0.015"–0.024" (0.38–0.6 mm.).

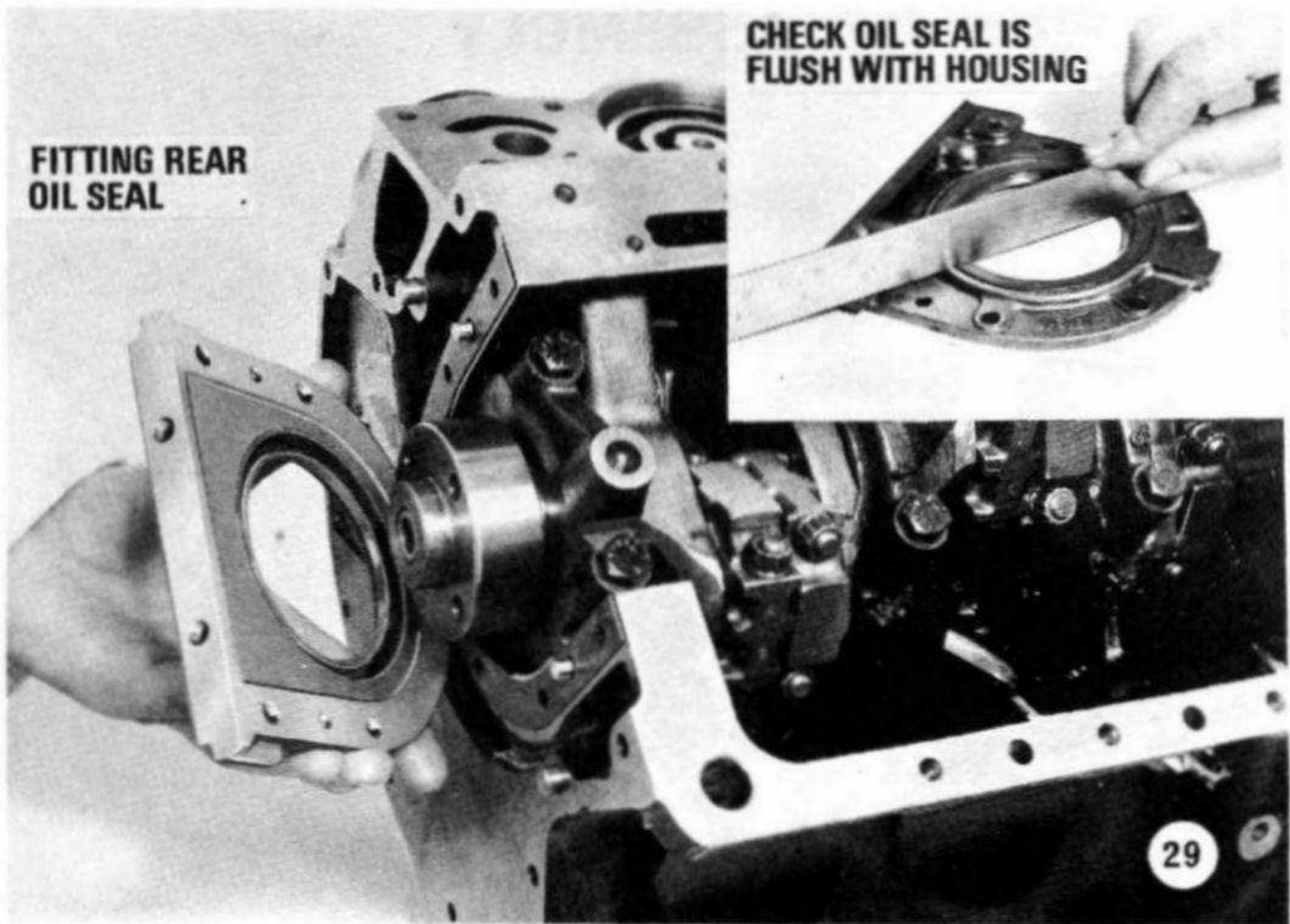

FRAME 29

REAR OIL SEAL

With the lip facing inwards, place the rear oil seal in the aluminium housing and press in until face of the seal and seal housing are flush. Check with a straight-edge.

Place housing gasket into position on block.

Lubricate the rear of the crankshaft with oil and gently ease rear oil seal and housing over the lead on the rear of crankshaft.

NOTE: Line up the two dowel holes in the rear oil seal housing with dowel pins in block.

Fit six bolts and spring washers, the two longer bolts being fitted to the bottom holes of the housing, and tighten to 7–9 lb. ft. (1.0–1.2 kg. m.).

OIL PICK-UP ASSEMBLY

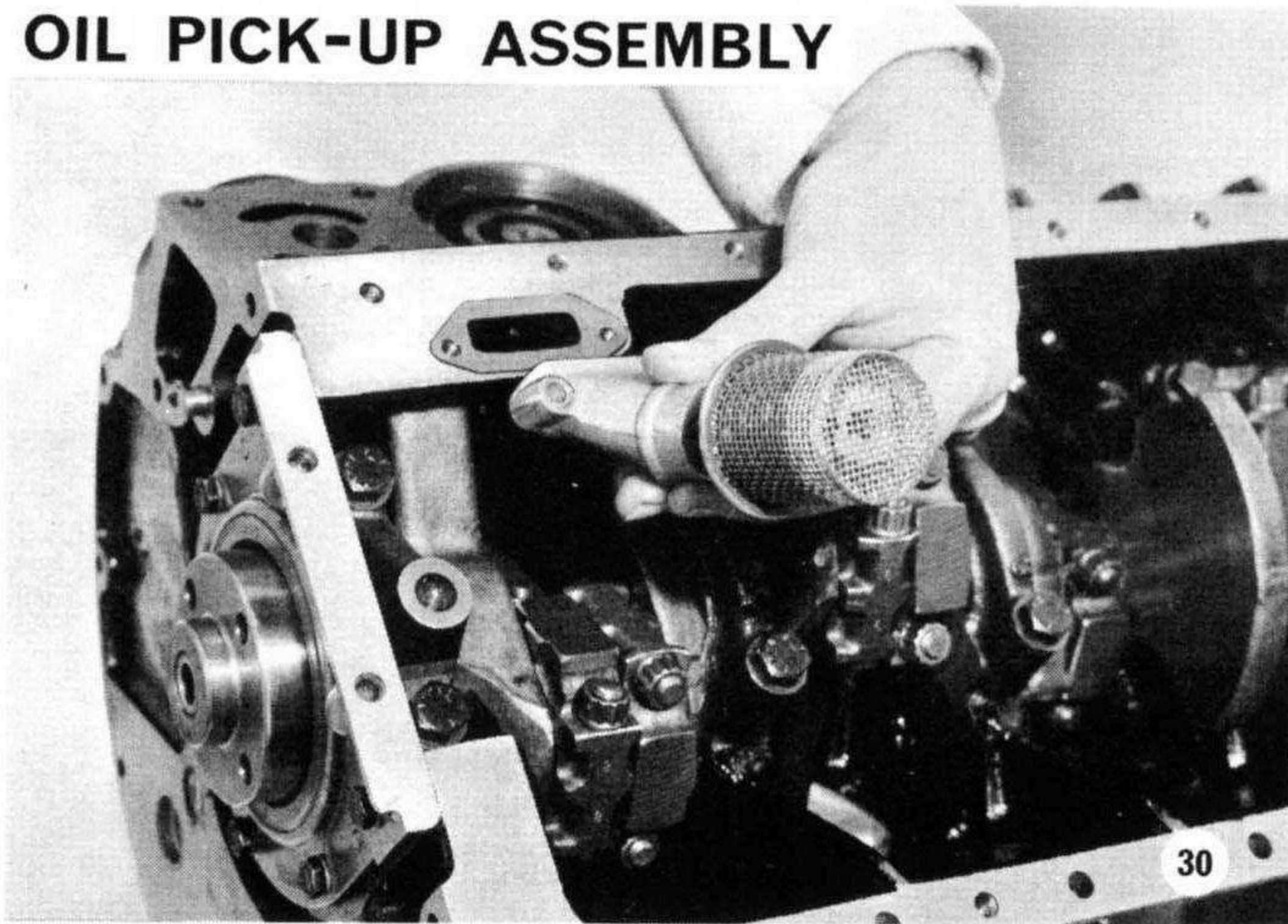

FRAME 30

OIL PICK-UP AND SUMP

The oil pick-up and gauze screen is held in position by two bolts and spring washers.

A gasket is fitted between the oil pick up and the cylinder block.

NOTE: If desired the sump may be fitted at this stage but all the sump bolts must be left slack to facilitate fitting the front timing cover at a later stage.

Replace sump gasket.

Replace sump and fit 14 bolts and washers.

Two extra-long bolts and nuts with special washers are fitted in two clearance holes drilled in the crankcase. The remaining five bolts and washers secure the sump to the front timing cover.

EXTENSION HOUSING ASSEMBLY

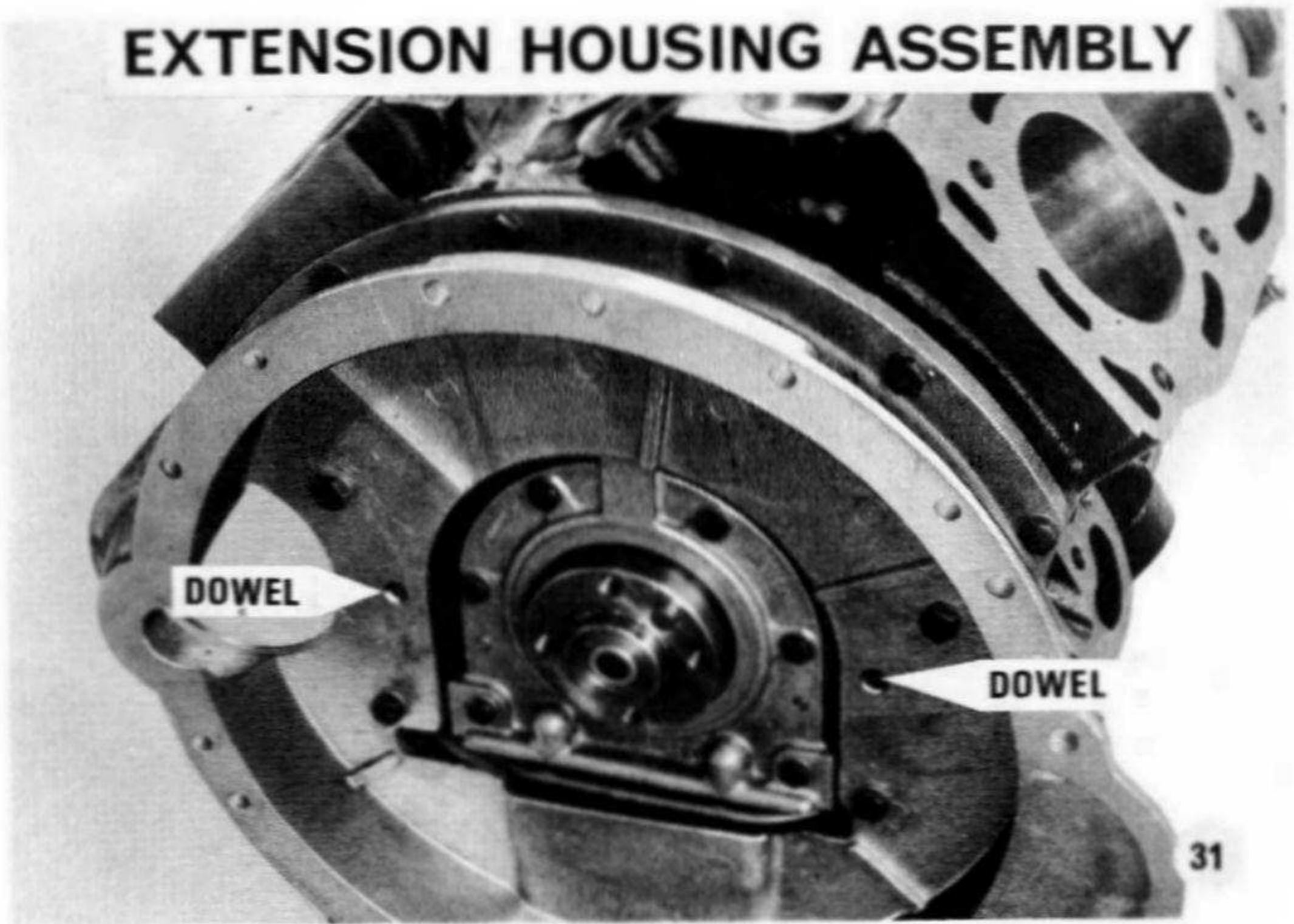

FRAME 31

FLYWHEEL EXTENSION HOUSING

The flywheel extension housing is located in position on the rear of the cylinder block by two dowels.

Offer up the extension housing to the two dowels and secure with 10 bolts and washers.

Tighten to 16–18 lb. ft. (2.2–2.5 kg. m.).

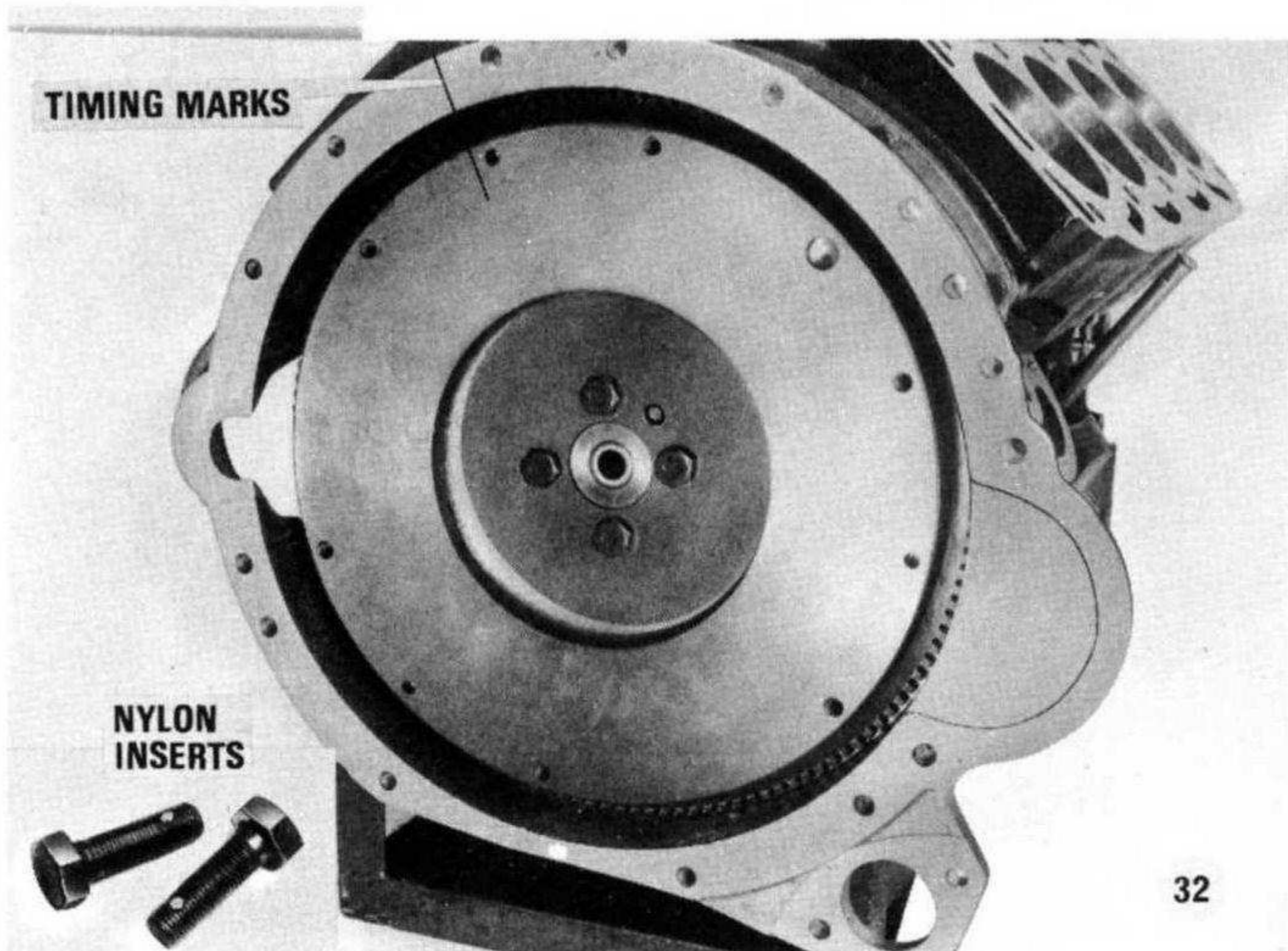

FRAME 32

FITTING THE FLYWHEEL

Fit the main shaft spigot bush to the rear of the crankshaft.

Before fitting flywheel ensure crankshaft end is flat.

NOTE: Remove any high spots round bolt holes with a smooth file or flat stone and thoroughly clean.

The flywheel is located to the crankshaft by a dowel and four bolts (six bolts on later cars). The inset shows the nylon insert fitted to the shank of the bolt. The bolts may be used twice only.

Tighten the four bolts to 38–45 lb. ft. (5.2–6.2 kg. m.). Check flywheel run-out which must not exceed 0.004" (0.1 mm.) at a 4" (10.1 cm.) radius.

Using marks stamped on the flywheel and extension housing turn engine until No. 2 piston is at T.D.C. left-hand bank.

NOTE: Camshaft timing set with No. 2 piston T.D.C.

The cast-iron flywheel has a hardened steel starter ring which can be replaced if the teeth become worn. If engine is out of car the clutch assembly may be left off until a later stage to facilitate timing the engine.

REFITTING IDLER SHAFT GEAR



FRAME 33

IDLER SHAFT

The idler shaft is supported at either end in the cylinder block and is driven by the left-hand timing chain.

The idler shaft has two skew gears machined into it, the front one driving the water pump and the rear one the distributor.

Hold the idler shaft firmly in a vice.

Place the idler shaft chain wheel, with the scribe line facing forwards, onto the idler shaft and align either of the dowel holes in the chain wheel with the dowel.

Fit the special tag washer to fit in the unused dowel hole.

Fit bolt and tighten to 30–37 lb. ft. (4.1–5.1 kg. m.).

Knock tab washer segment onto bolt head.

Lubricate the idler shaft bearing and gear surfaces and slide into position in cylinder block.

NOTE: Check idler shaft gear for run-out.

**FITTING IDLER SHAFT KEEP PLATE.
TORQUE SCREWS TO 18-20 lb ft (2.5-2.7 kgm)**

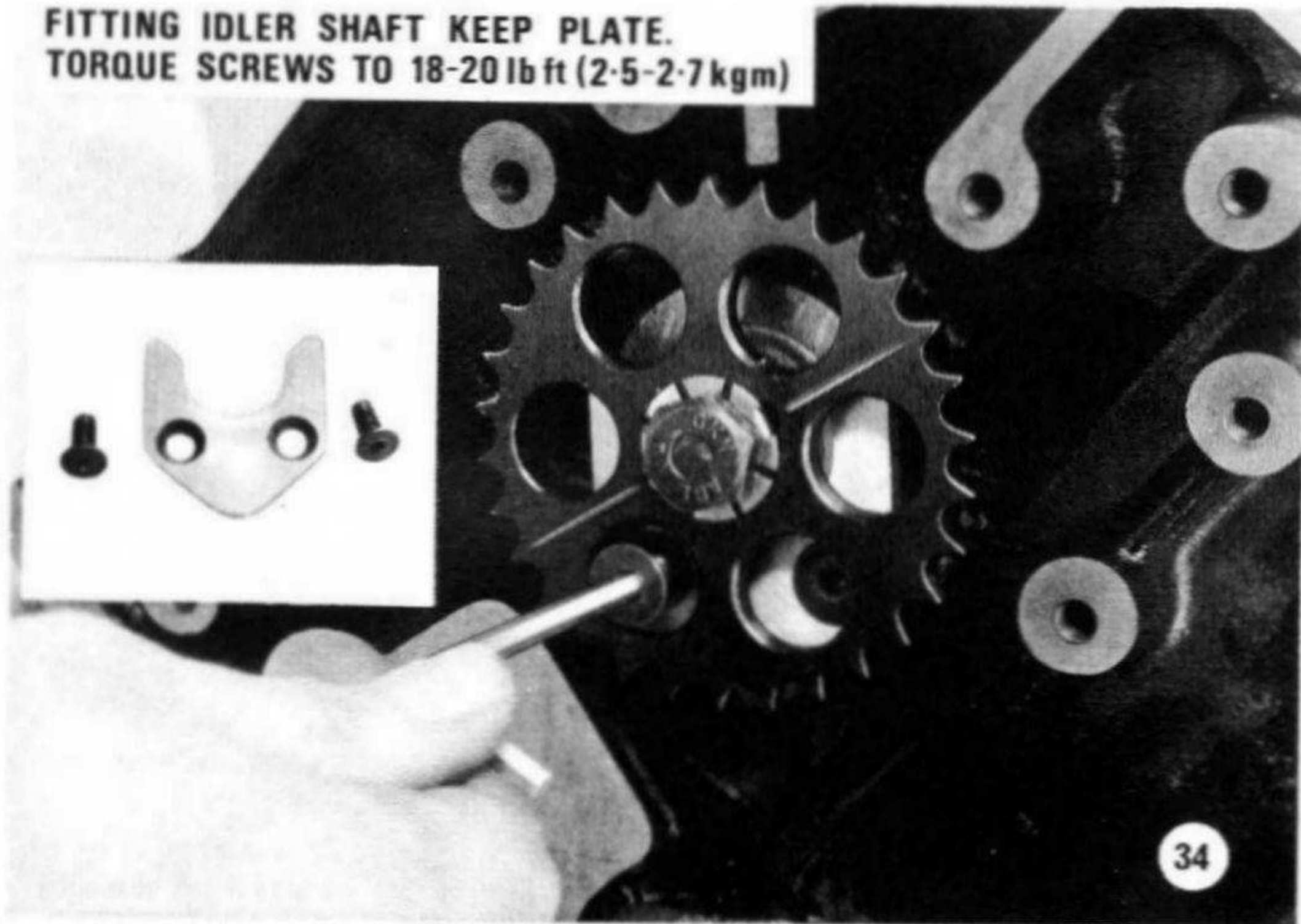

FRAME 34

Locate the idler shaft retaining plate into position in the annular groove on the shaft.

Fit the two $\frac{3}{16}$ " (4.7 mm.) Allen screws securing the plate to cylinder block and tighten to 18-20 lb. ft. (2.5-2.7 kg. m.).

REFITTING WATER PUMP

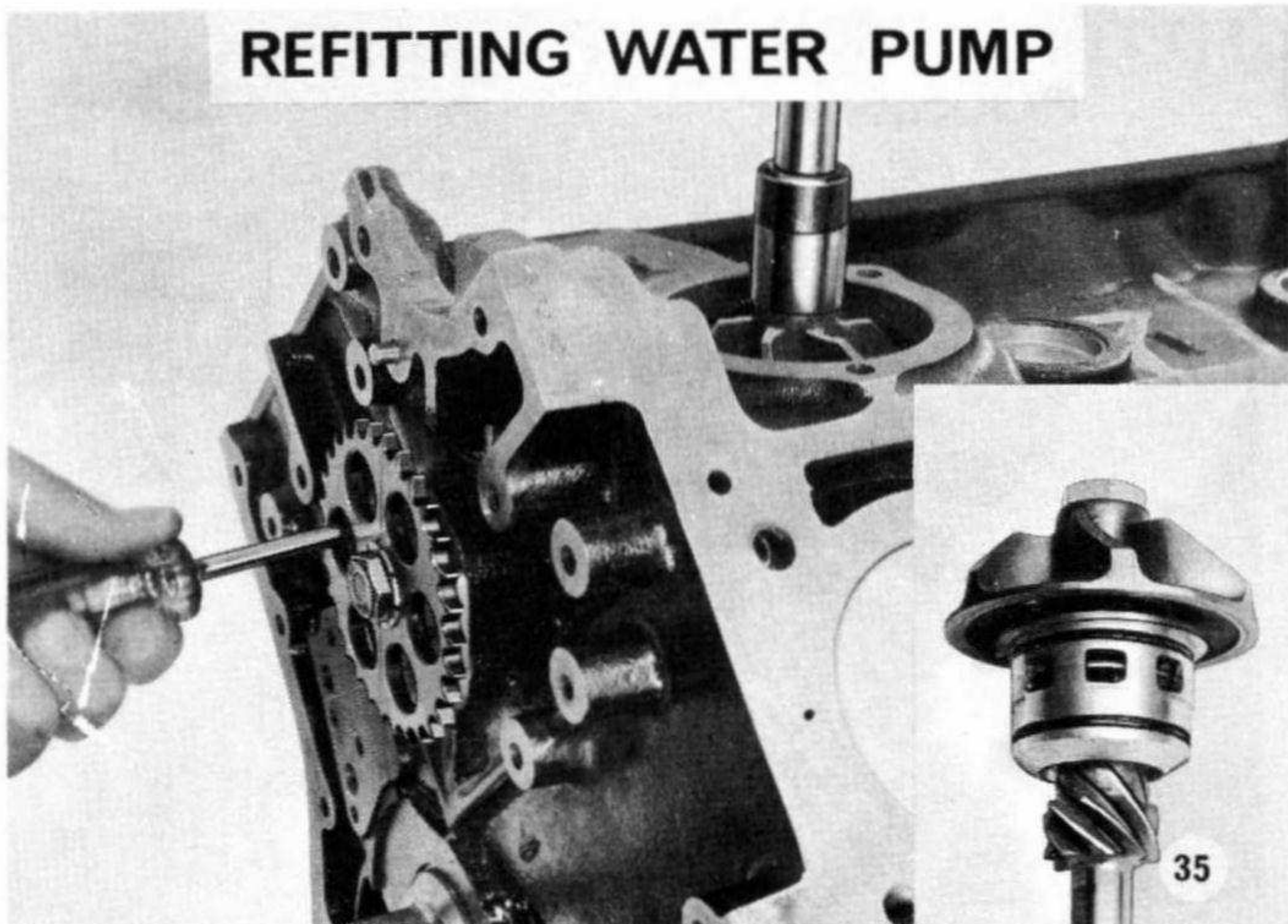

FRAME 35

REFITTING WATER PUMP

The water pump housing is situated between the two banks of cylinders integral with the cylinder block.

The impeller-type pump is driven by a skew gear on the idler shaft.

NOTE: When removing the water pump apply a socket spanner to the bolt head, which has a LEFT-HAND thread, and gently rock in a clockwise direction with the idler shaft held stationary. If assembly does not unscrew and disengage itself from the block due to tightness, the bolt securing the impeller will unscrew. The pump assembly can then be removed using an impact hammer and adaptor 54235A/6 4235A (3072) (see page 90).

Before refitting the water pump ensure that the pump spigot bearing in the cylinder block is in good condition. Place water pump assembly in position in cylinder block and slowly rotate the idler shaft to mesh gears. Fit socket to impeller retaining bolt and turn in an anti-clockwise direction to fully seat assembly, at the same time holding the idler shaft stationary.

NOTE: Do not tap nut with hammer to seat pump as this may fracture the graphite seal.

FITTING WATER PUMP HOUSING

CLEARANCE, - 0.010" - 0.020"
- .25mm - .5mm

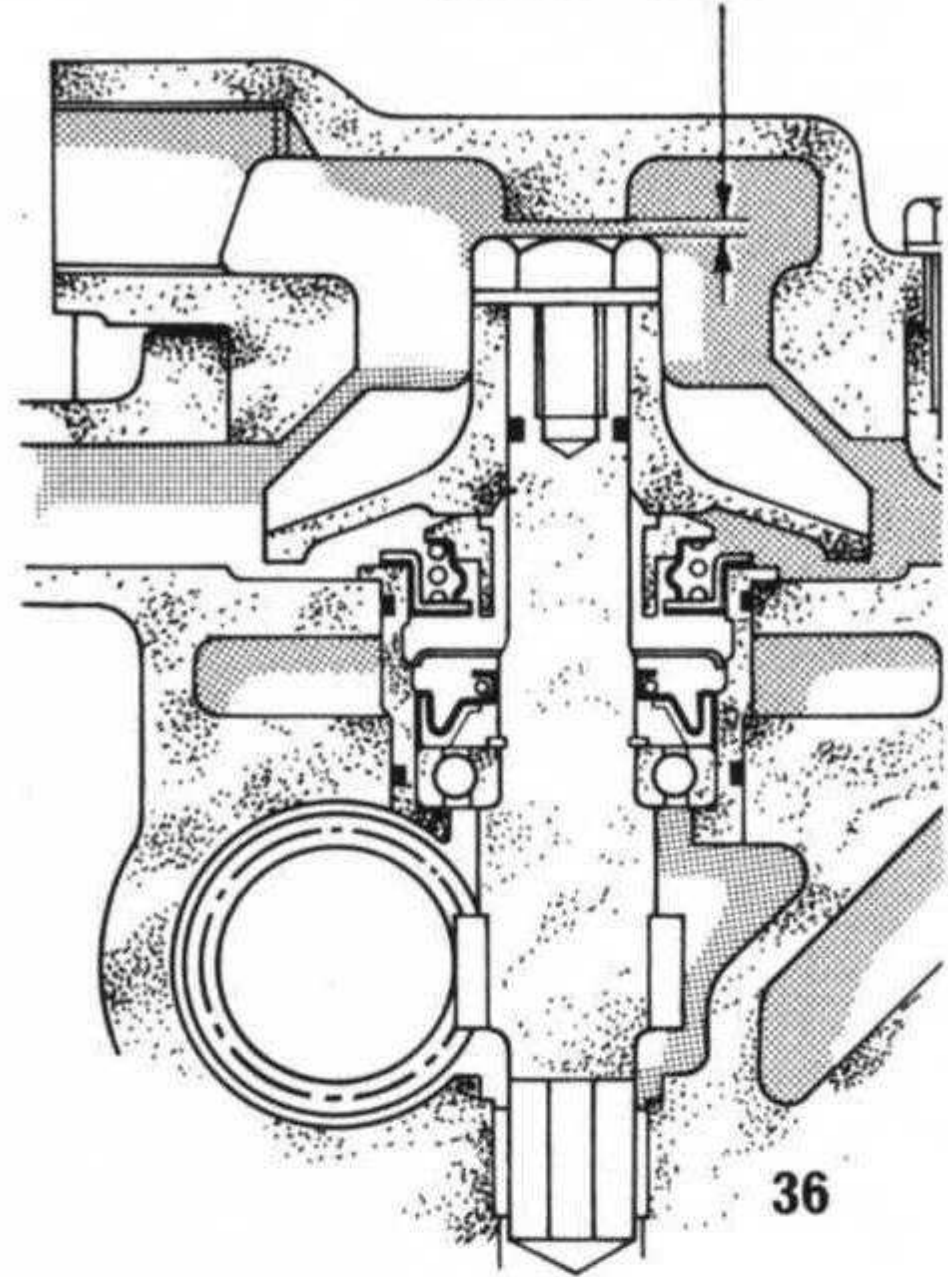
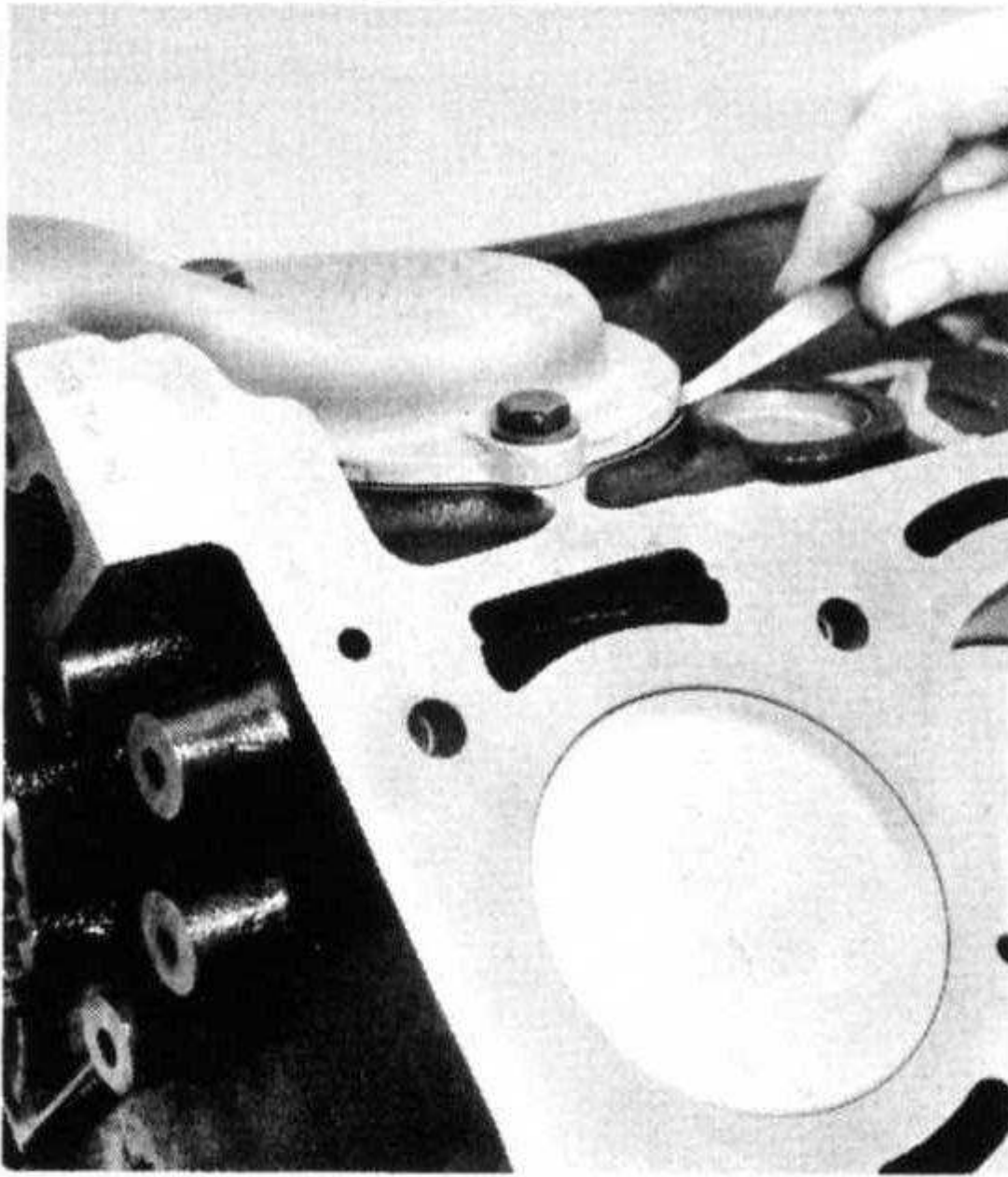

FRAME 36

FITTING WATER PUMP HOUSING

Assemble the water pump housing to the cylinder block without gaskets. Fit the three securing bolts finger-tight.

Using feeler gauges between the housing and cylinder block adjust the gap, by means of the bolts, to give an equal reading on the three segments.

Select gaskets to give 0.010"–0.020" (0.25–0.5 mm.) clearance between the impeller retaining bolt and lug on housing.

Example :

Gap between housing and block 0.010" (0.25 mm.).

Gaskets selected—total thickness 0.025" (0.63 mm.).

Clearance obtained 0.013" (0.38 mm.).

Fit the two heater pipes to the water pump housing and secure with three bolts and plain washers tightened to 18–20 lb. ft. (2.5–2.7 kg. m.).

TIMING CHAIN TENSIONER ASSEMBLY

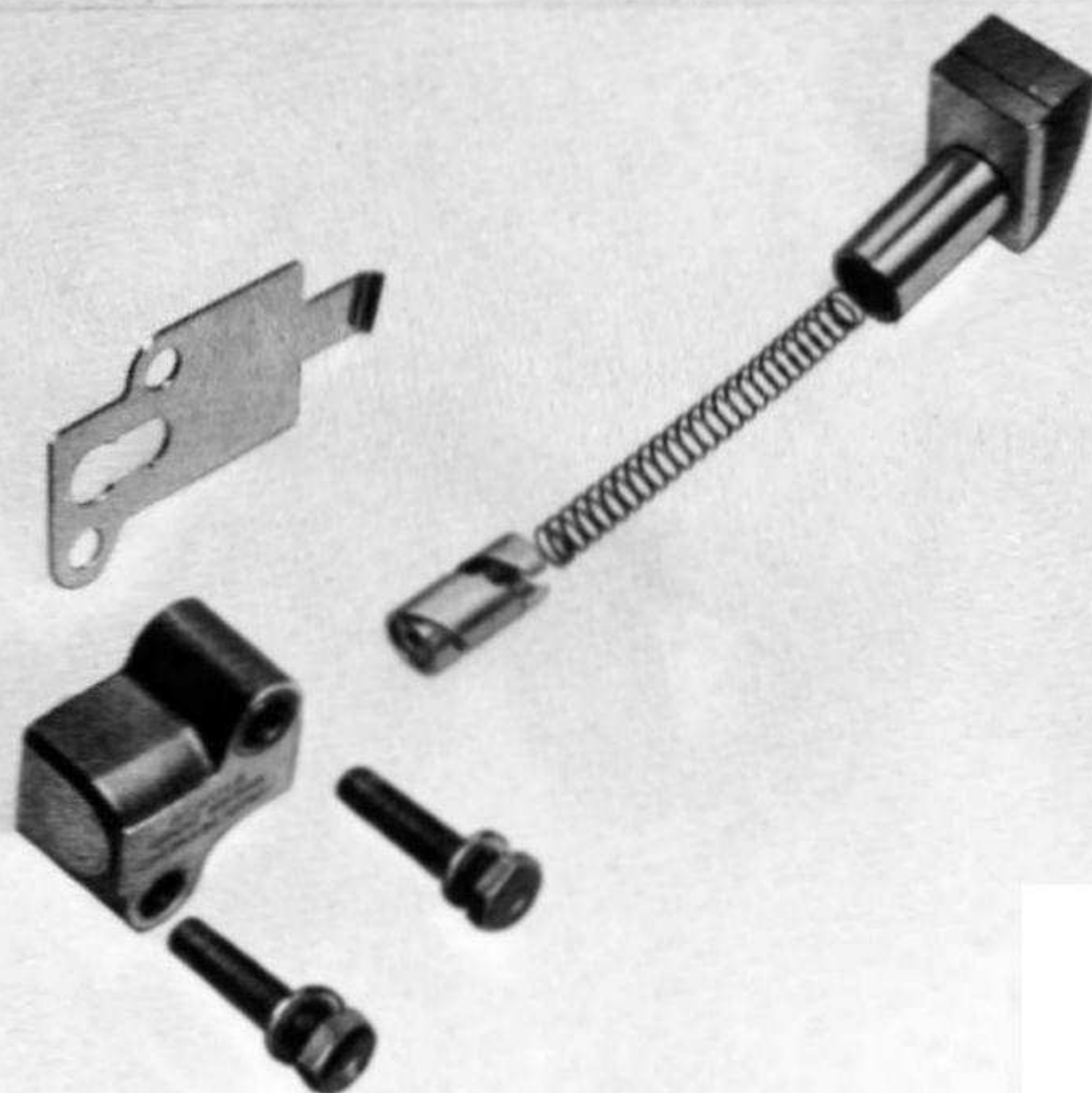

37

FRAME 37

CHAIN TENSIONERS

The two timing chain tensioners are of the hydraulic type and consist of an oil-resistant rubber slipper mounted on a plunger which bears on the outside of the chain. The spring, cased by the restraint cylinder and the plunger, in combination with oil pressure holds the slipper head against the chain keeping it in correct tension.

Return movement of the slipper head is prevented by the limit peg at the bottom end of the plunger bore engaging the nearest tooth in the helical slot of the restraint cylinder. The oil is introduced into the adjuster body via a drilling from the cylinder block.

The backing plate, which incorporates a travel limiting stop, provides a suitable face along which the slipper head can work.

A small hole in the slipper head face provides lubrication.

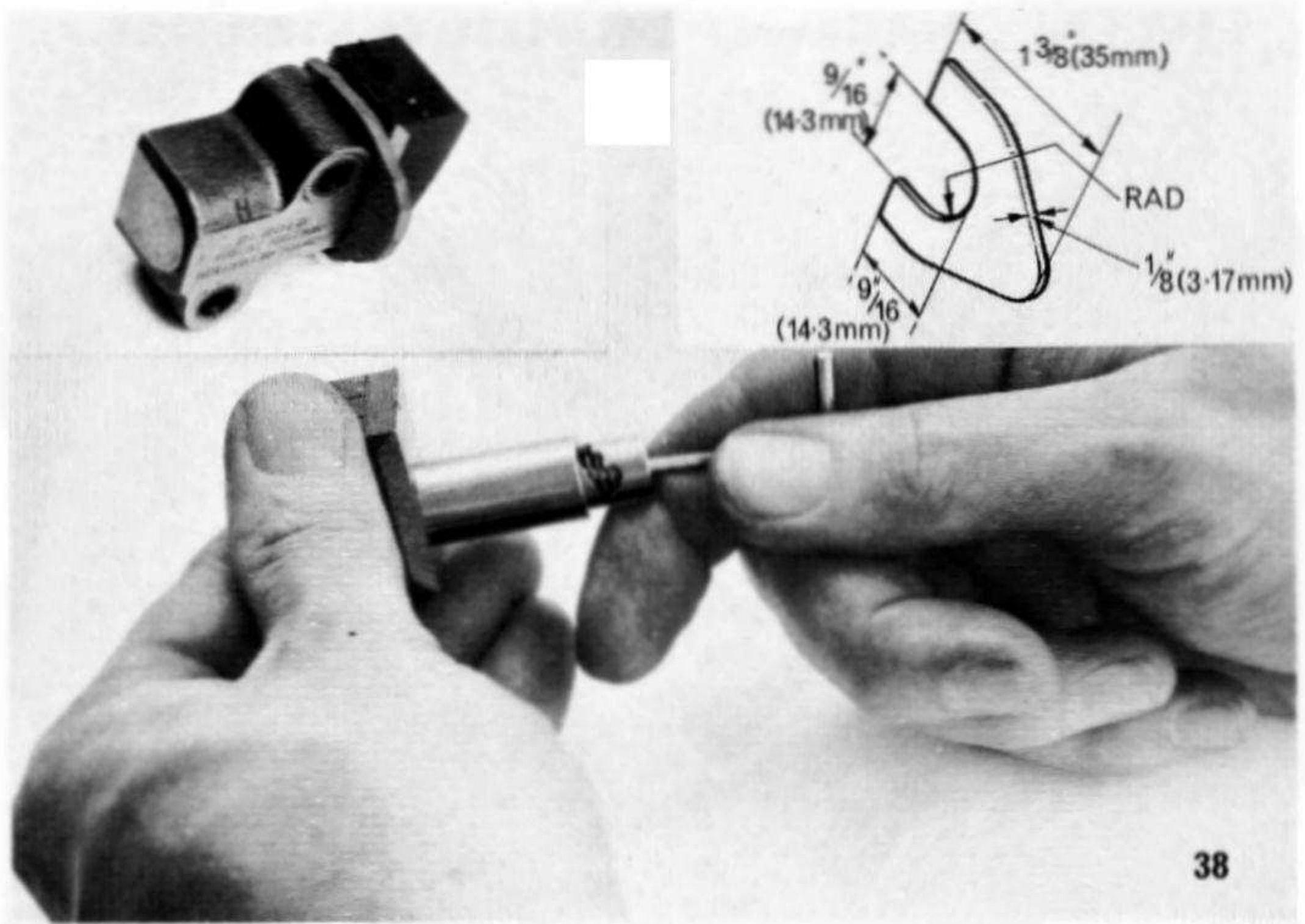

38

FRAME 38

CHAIN TENSIONER ASSEMBLY

Assemble the plunger, restraint cylinder and spring. Insert an Allen key (0.125" A/F) (3.1 mm.) into the restraint cylinder and turn key in a clockwise direction until the slipper head remains in the retracted position.

Make a cardboard template to the dimension shown in the illustration and place in position behind slipper head on plunger.

The cardboard template prevents accidental actuation of the spring when assembling the plunger to the tensioner body.

NOTE: DO NOT remove cardboard spacer until final chain adjustment takes place.

Offer up tensioner and travel limiting plate to the lower of the two chain tensioner mounting points on the cylinder block and ensure the oil feed dowel is in position. Secure chain tensioner with two bolts and washers and tighten to 7-9 lb. ft. (1.0-1.2 kg. m.).

CYLINDER NUMBERING

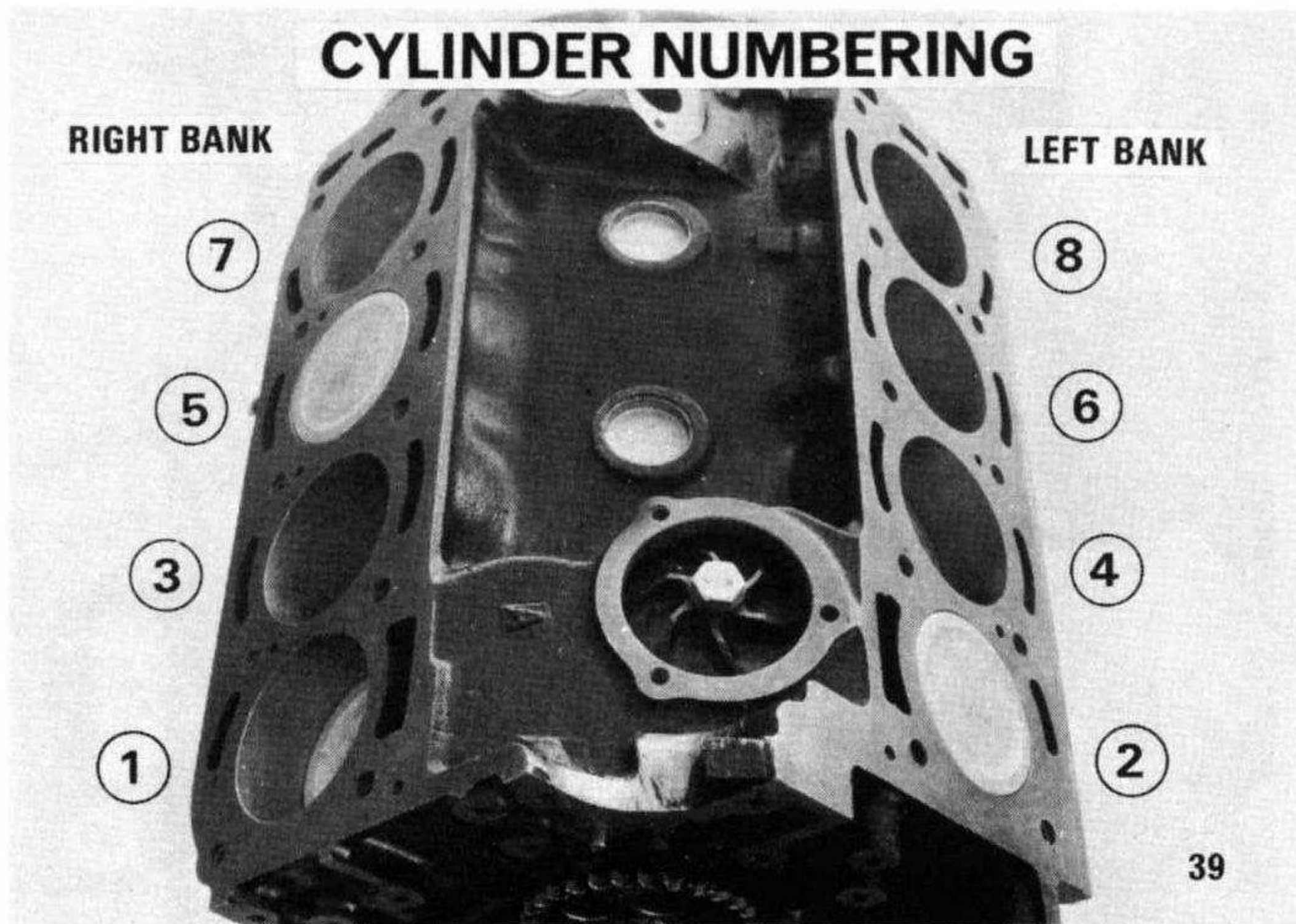

FRAME 39

CYLINDER NUMBERING SEQUENCE

The cylinders of the V8 engine are numbered as follows, even numbers on the left-hand bank and odd numbers on the right-hand bank, as shown in the illustration.

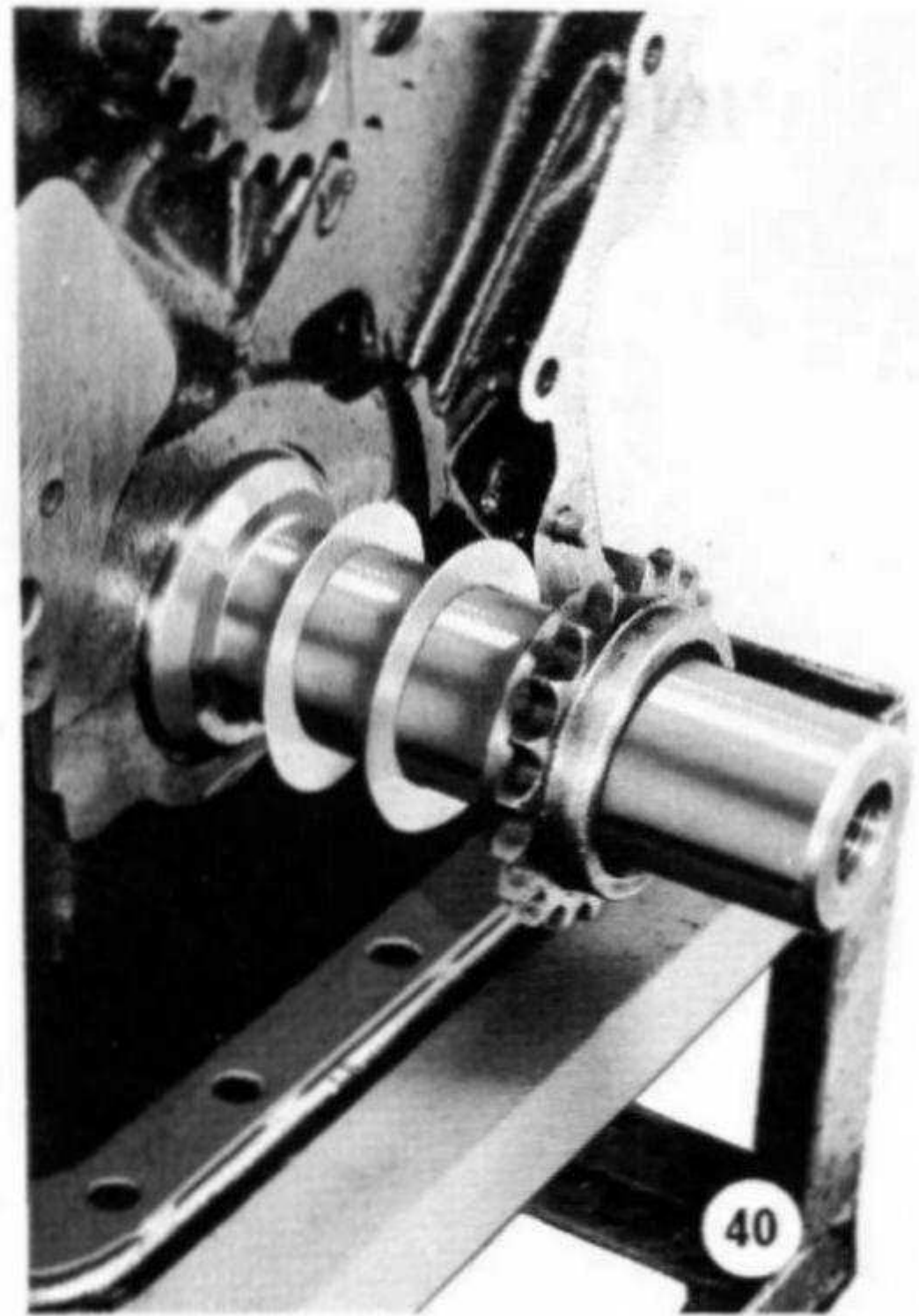
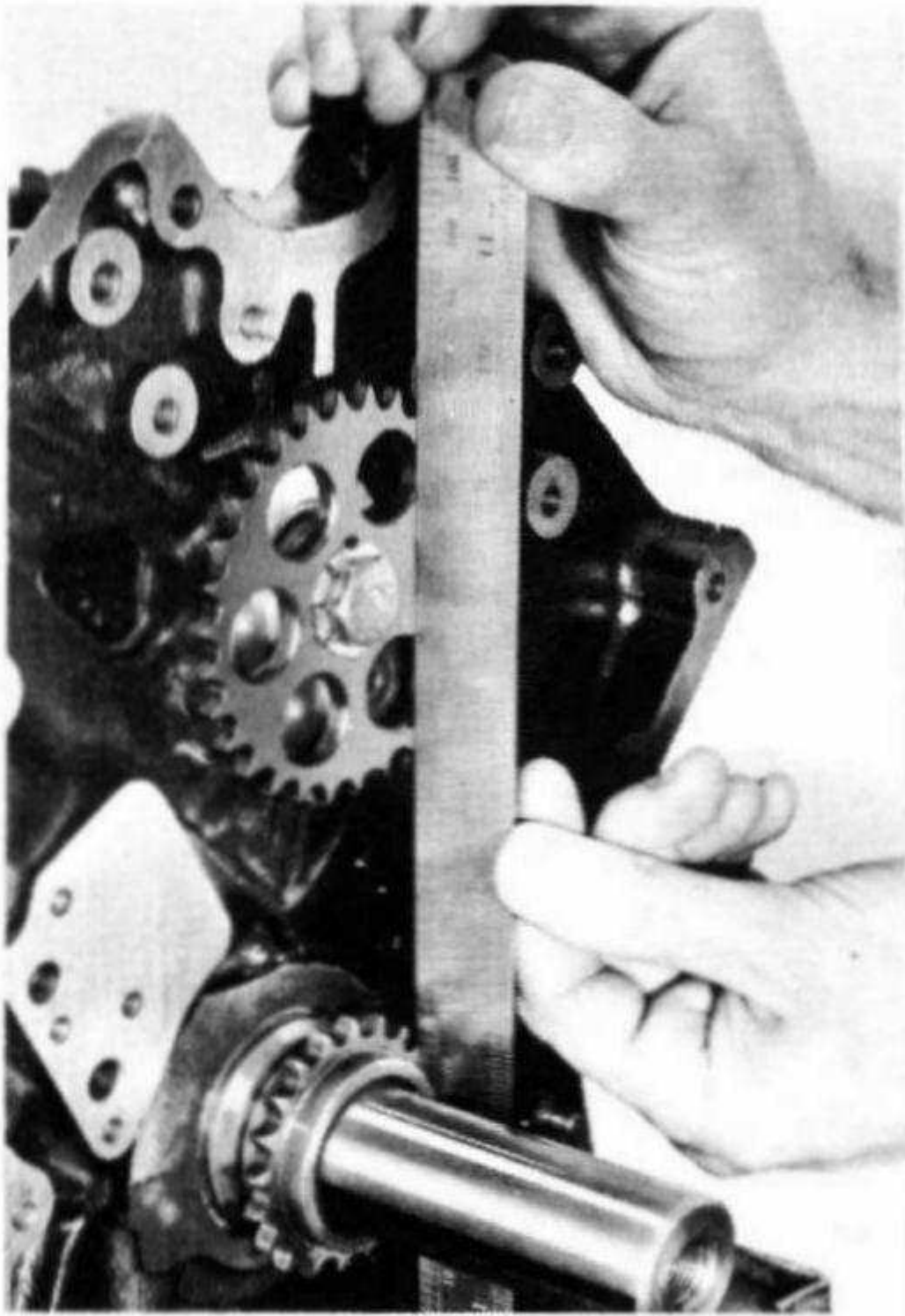

FRAME 40

CHAIN SPROCKET ALIGNMENT

Before refitting or renewing the two lower chain sprockets ensure that the teeth on the sprockets are in line with each other. When two sprockets have been selected centre pop mark the front face of each one to facilitate reassembly.

It is essential that the idler sprocket and crankshaft drive inner sprocket are checked for alignment using a straight-edge as shown.

If the sprockets do not line up, place the appropriate amount of shims behind the sprocket on the crankshaft.

There are two sizes of shims, 0.004" (0.10 mm.) and 0.006" (0.15 mm.).

LEFT HAND BANK TIMING CHAIN ASSEMBLY

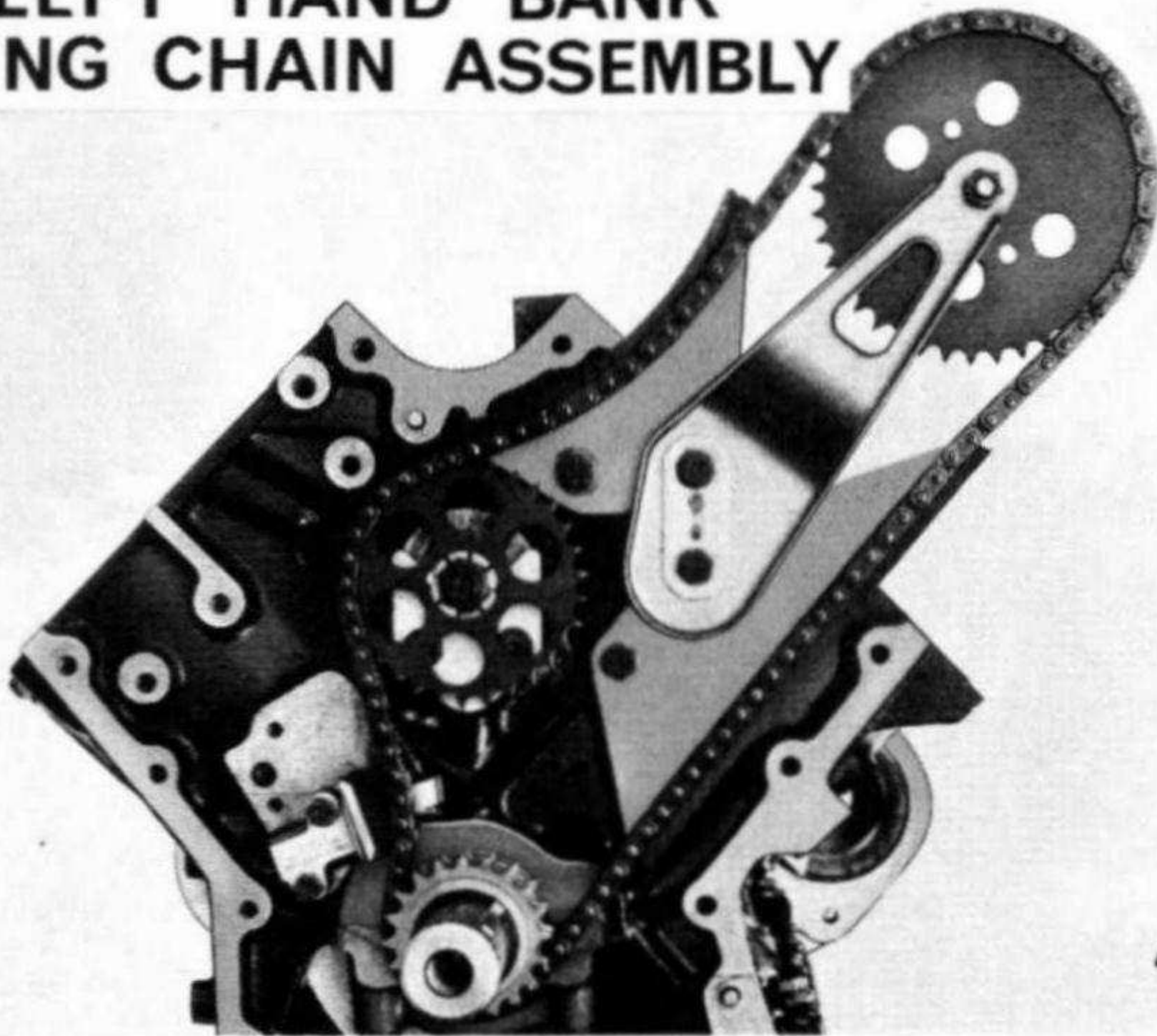

FRAME 41

PART 5

TIMING CHAIN ASSEMBLY (LEFT-HAND)

Fit Woodruff key to keyway nearest to block on nose of crankshaft.

Fit the two timing chain sprockets onto the crankshaft.

Rotate crankshaft to T.D.C. No. 2 cylinder, using marks stamped on flywheel and aluminium extension casing.

Assemble large chain wheel onto mounting bracket.

Rotate idler shaft until scribe mark is tilting down slightly on side nearest left-hand bank and the dowel is facing the right-hand bank as shown.

NOTE: The left-hand timing chain has two extra links.

Assemble timing chain to all sprockets and ENSURE crankshaft and idler shaft sprockets DO NOT move.

Offer up two chain guides, sprocket and mounting bracket to cylinder block.

NOTE: The bolt securing the adjustable end of the top chain guide has a plain and spring washer fitted.

FITTING LEFT HAND CYLINDER HEAD

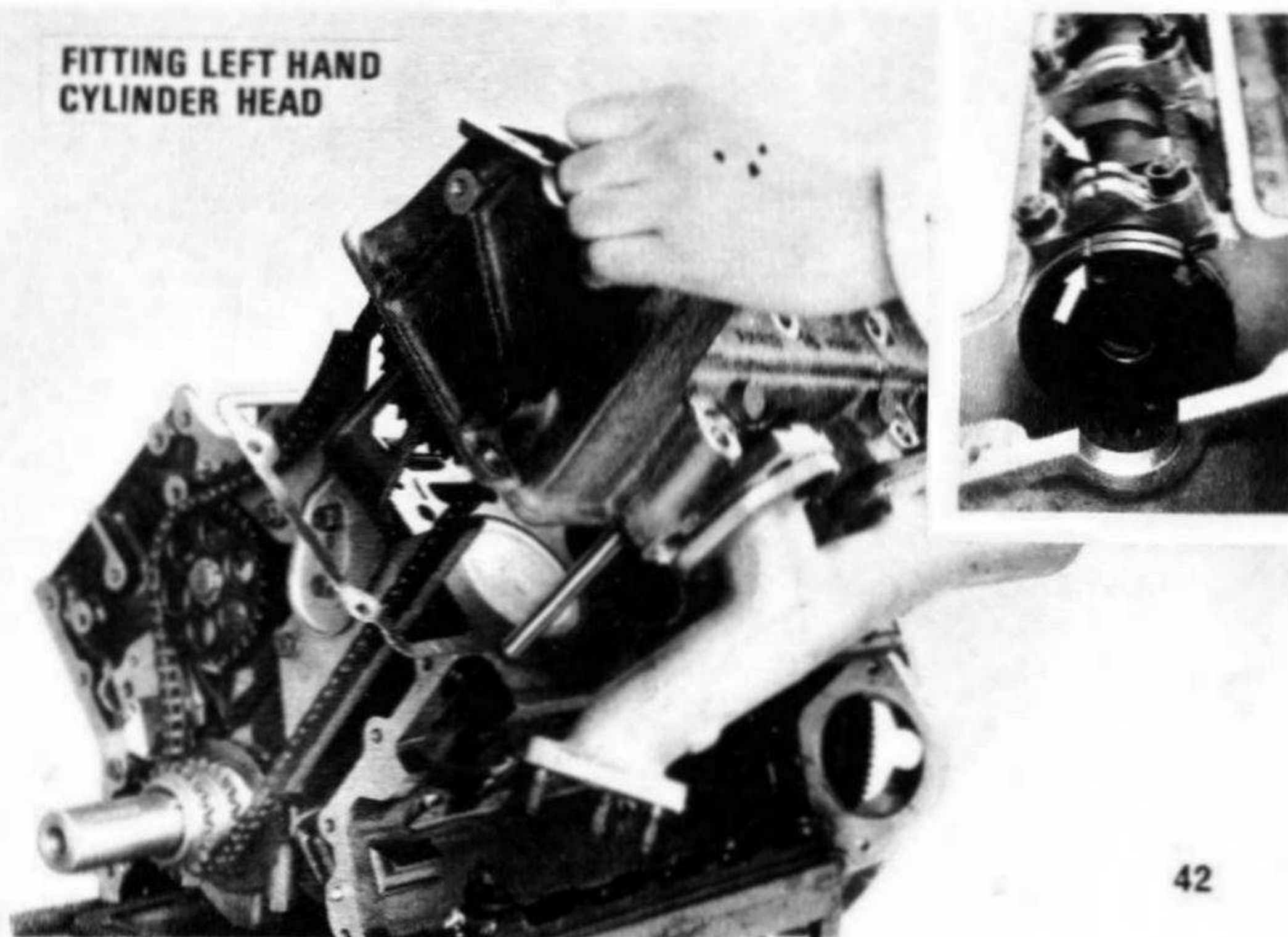

42

FRAME 42

REFITTING THE LEFT-HAND CYLINDER HEAD

Turn camshaft on cylinder head so that the scribe marks stamped on the driving flange of the crankshaft and front bearing line up.

To facilitate reassembly of the cylinder head use two of the long head studs, with screwdriver slots in the position shown in the illustration.

Ensure cylinder block face is clean.

Fit the cylinder head gasket.

Lower the left-hand cylinder head into position over the two head studs and timing chain.

Fit two short and one long head bolts and washers.

Replace head locating studs with long bolts and washers **FINGER-TIGHT ONLY**.

Screw the five long head studs into position with a screwdriver and fit washers and nuts.

NOTE: DO NOT TURN CAMSHAFT OR CRANKSHAFT with the cylinder head fitted and the timing chain disconnected. The valves protrude below the face of the cylinder head and will foul the pistons.

Tighten cylinder head nuts and bolts in the sequences shown in Frame 3.
Offer up the inlet manifold and gaskets to left-hand cylinder head.
Fit inlet manifold securing bolts and washers. Leave these bolts loose.

LEFT HAND TIMING CHAIN ASSEMBLY

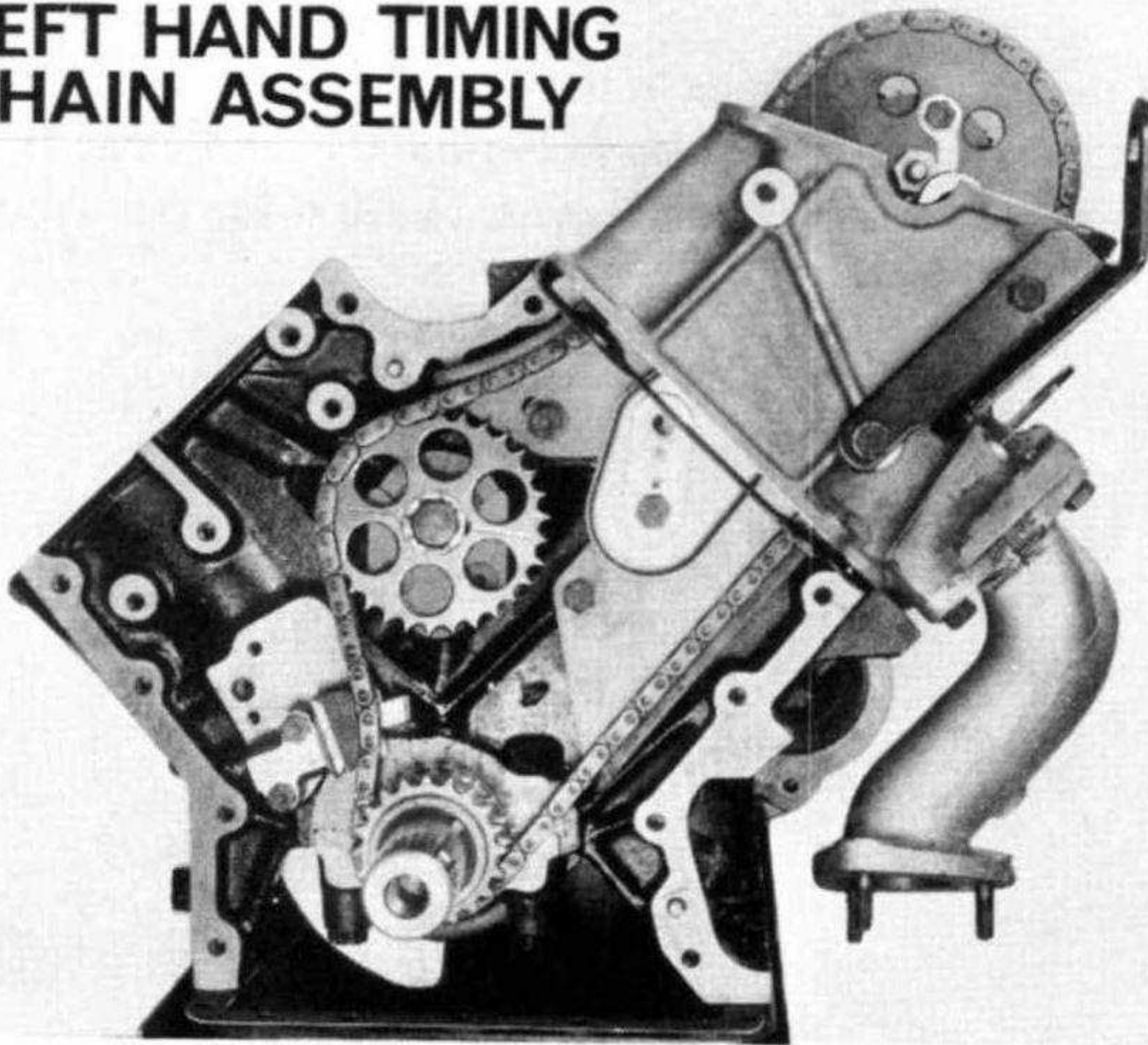

FRAME 43

TIMING THE LEFT-HAND CAMSHAFT

Remove nut securing the large chain sprocket to the mounting bracket.

Remove top bolt securing sprocket mounting bracket and slacken bottom bolt.

Move bracket to one side as shown.

Rotate sprocket within chain one tooth at a time until securing holes line up with flange on camshaft.

Press sprocket spigot into hole in camshaft flange.

Fit **one** sprocket securing bolt and tab washer and tighten to 7–9 lb. ft. (0.9–1.2 kg. m.).

NOTE: Care should be taken to line up tab washer with other hole in sprocket to facilitate fitting other securing bolt at a later stage.

Refit both sprocket mounting bracket bolts leaving the top one loose.

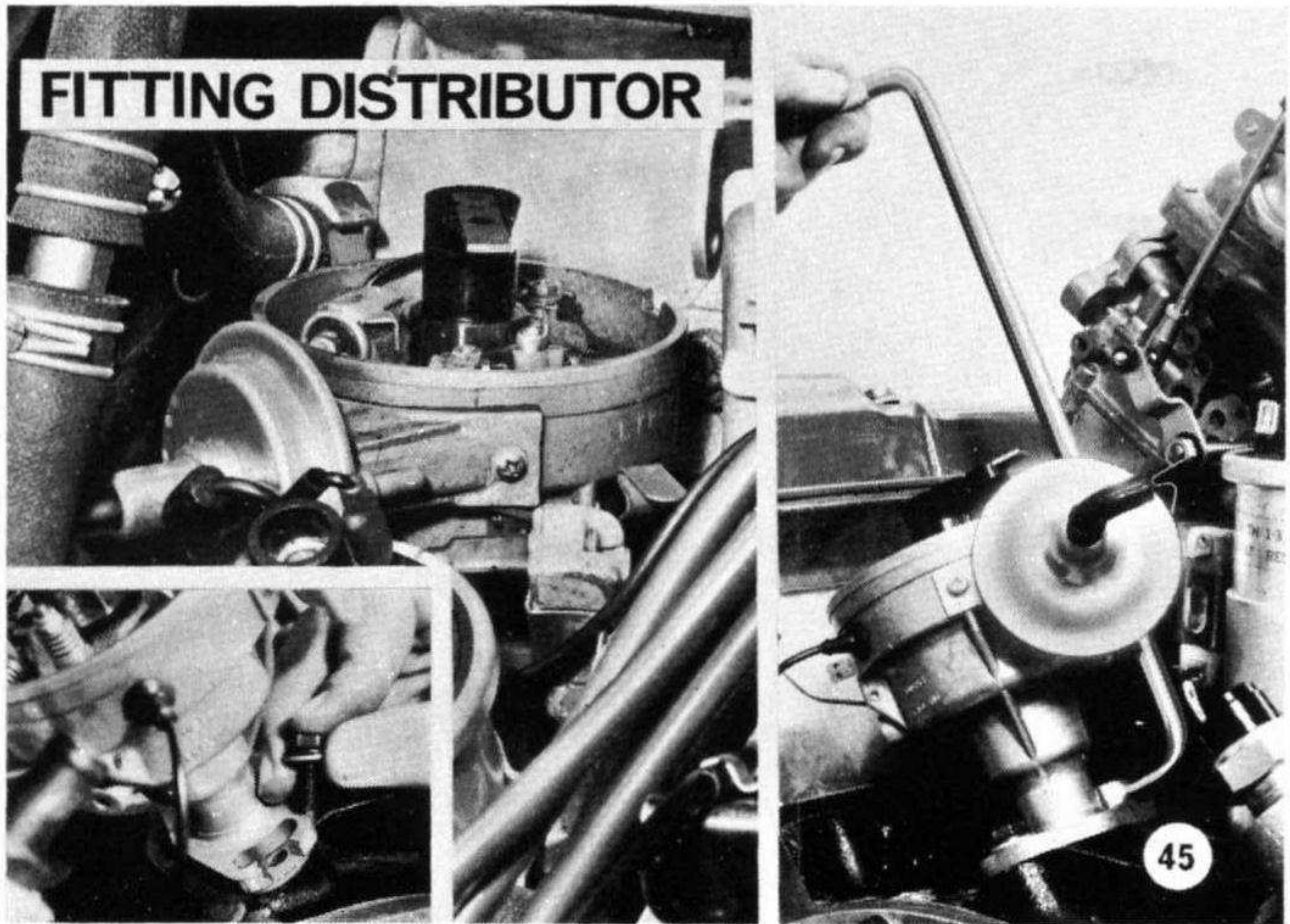

FRAME 45

FITTING THE DISTRIBUTOR

Ensure engine is on T.D.C. No. 2 cylinder firing by checking timing marks on flywheel and aluminium extension housing.

Slide the distributor into position in the block.

With the distributor in the correct position the rotor arm should face the screw on the outer body as shown in the illustration and the distributor securing bolt holes in the cylinder block should be in approximately the mid position of the distributor retaining flange.

Failure to achieve the above condition may be due to the distributor drive gear being one tooth out of alignment, in which case it will be necessary to withdraw distributor and refit correctly.

If condition still exists, check position of idler gear scribe-mark and position of dowel.

If scribe-mark is in the wrong position it will be necessary to strip and reset timing chain arrangement as described on pages 47–51.

Fit two bolts and washers securing distributor to cylinder block.

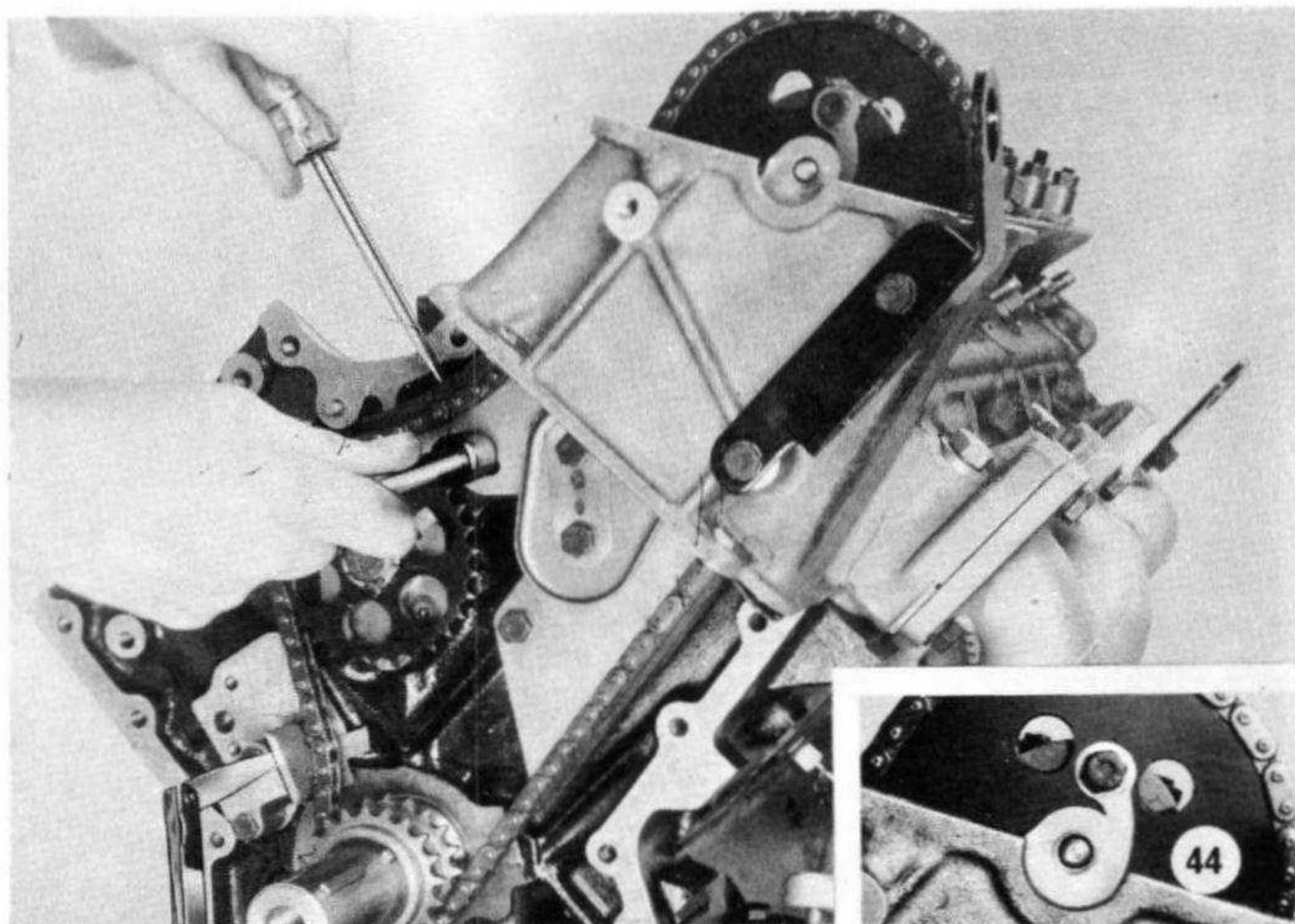

FRAME 44

Remove cardboard spacer from chain tensioner carefully to avoid actuating unit.

Insert 0.100" (2.5 mm.) shim between the tensioner head and body.

Remove all slackness from the chain and tighten the chain guide adjustment bolt.

Tighten chain guide bolts to 18–20 lb. ft. (2.5–2.7 kg. m.).

NOTE: Ensure there is clearance between the thread on the sprocket spigot and the hole in mounting bracket as shown in inset.

Remove 0.100" (2.5 mm.) shim.

Ensure chain is running on chain guide rubber.

IT IS MOST IMPORTANT to check the position of the idler shaft scribe-mark when timing is completed on the left-hand bank. The scribe-mark **MUST** tilt down slightly as shown in the illustration.

Failure to achieve this condition will cause the distributor to be out of alignment.

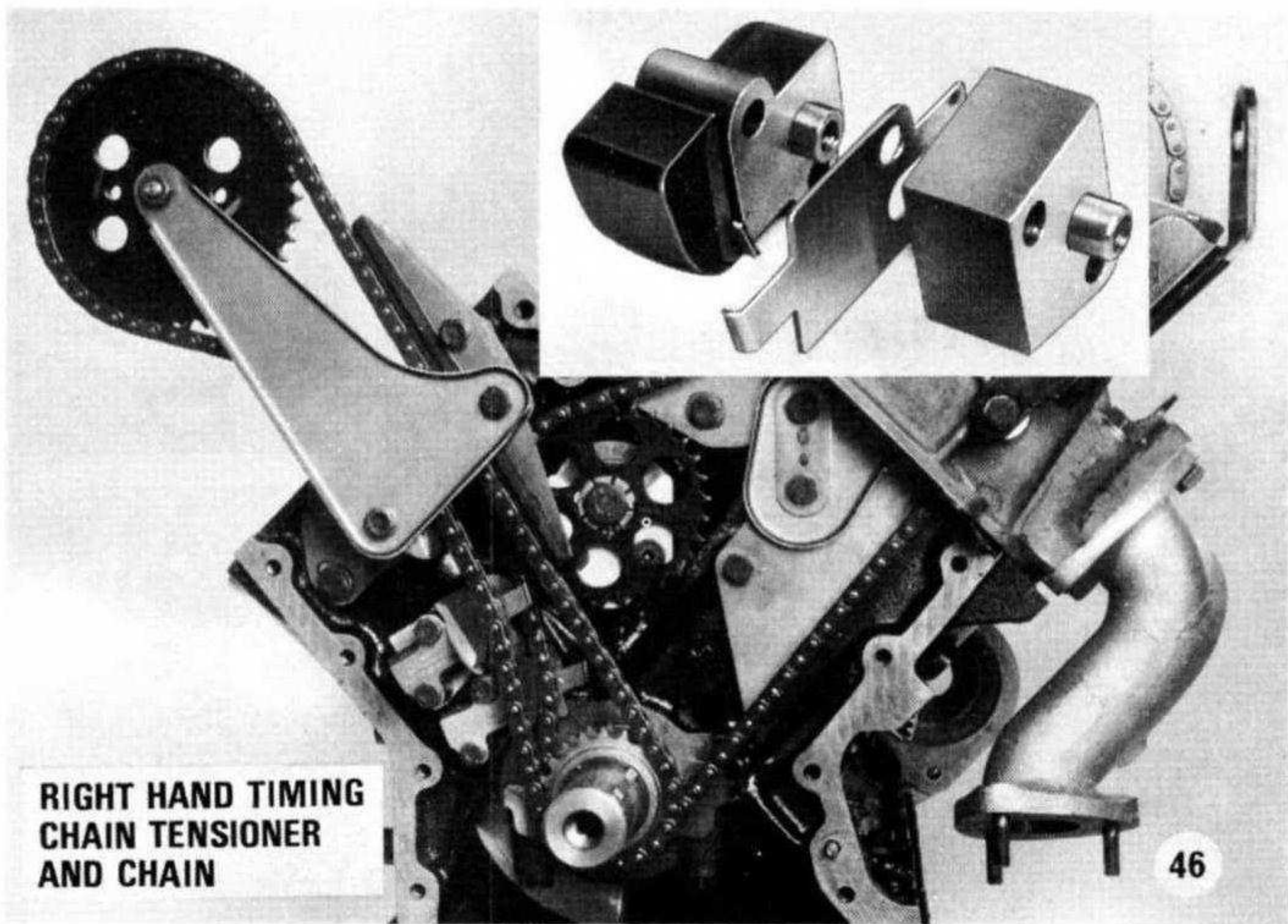

FRAME 46

TIMING CHAIN ASSEMBLY (RIGHT-HAND)

Assemble the timing chain tensioner with cardboard spacer in position.

NOTE: An extension block is fitted behind the timing chain tensioner for the right-hand bank. There are two oil feed dowels, one on the extension block and one on the chain tensioner.

The backing plate is fitted between the chain tensioner body and the extension block.

Assemble the large chain sprocket to the mounting bracket.

Assemble the chain onto the sprockets and offer up the mounting bracket and chain guides to the cylinder block. Tubular spacers are fitted to both the chain guides.

NOTE: The bolt fitted to the chain guide elongated hole has a plain and spring washer.

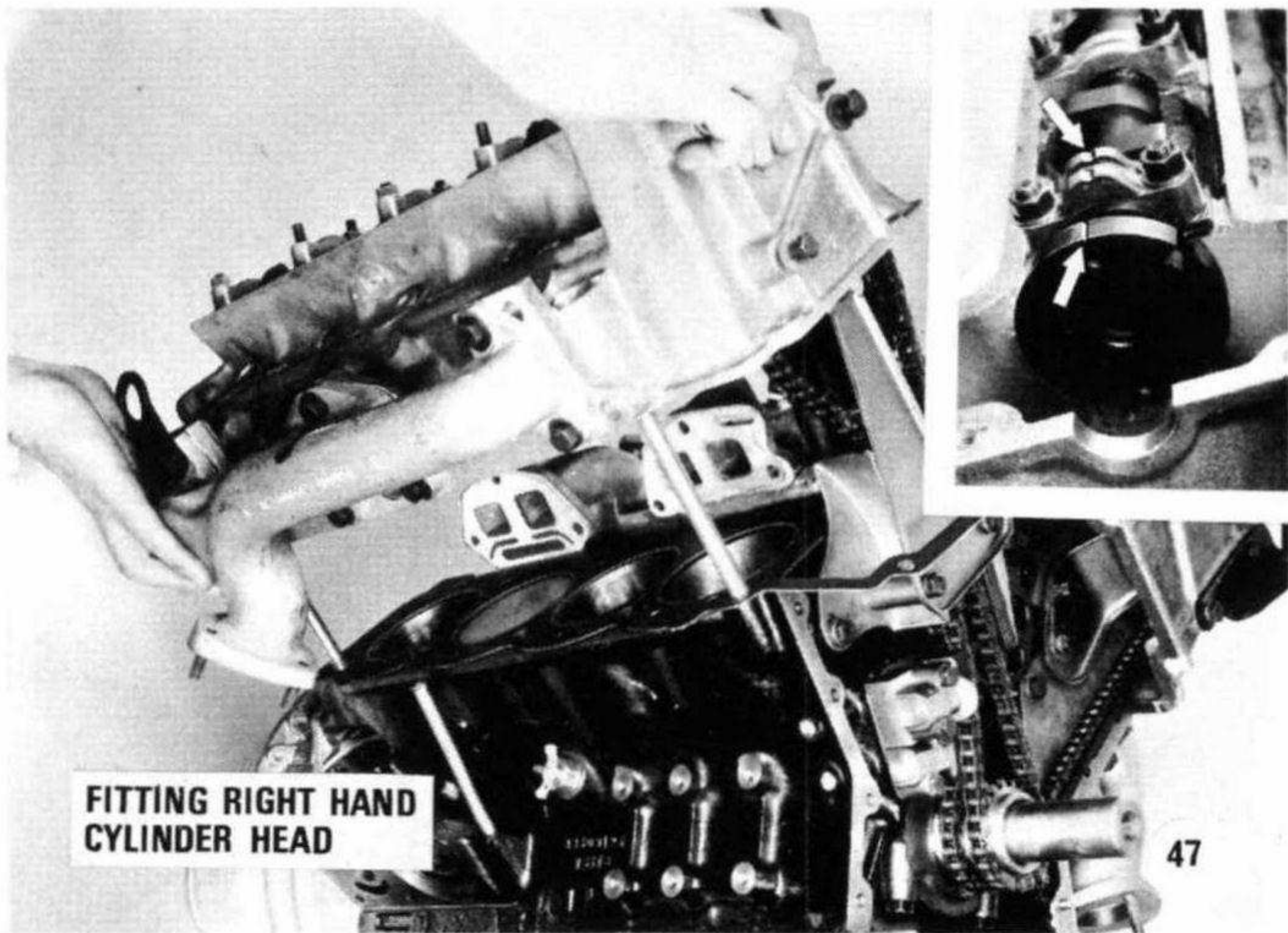

FRAME 47

FITTING THE RIGHT-HAND CYLINDER HEAD

Turn camshaft, on cylinder head, until the scribe-marks stamped on the driving flange and the camshaft front bearing cap line up.

Using two long cylinder head studs as shown, place the right-hand cylinder head and gasket in position.

The procedure for refitting cylinder head is the same as given in Frame 42.

NOTE: Before **TIGHTENING** the cylinder head it is essential to fit the remaining inlet manifold gaskets and secure the manifold to the right-hand cylinder head.

Tighten the inlet manifold to the left-hand head.

Tighten the inlet manifold to the right-hand head.

Failure to observe this procedure may result in the manifold fracturing.

Finally, tighten the right-hand cylinder head nuts and bolt to 50–55 lb. ft. (6.9–7.6 kg. m.) in the sequence shown in Frame 3.

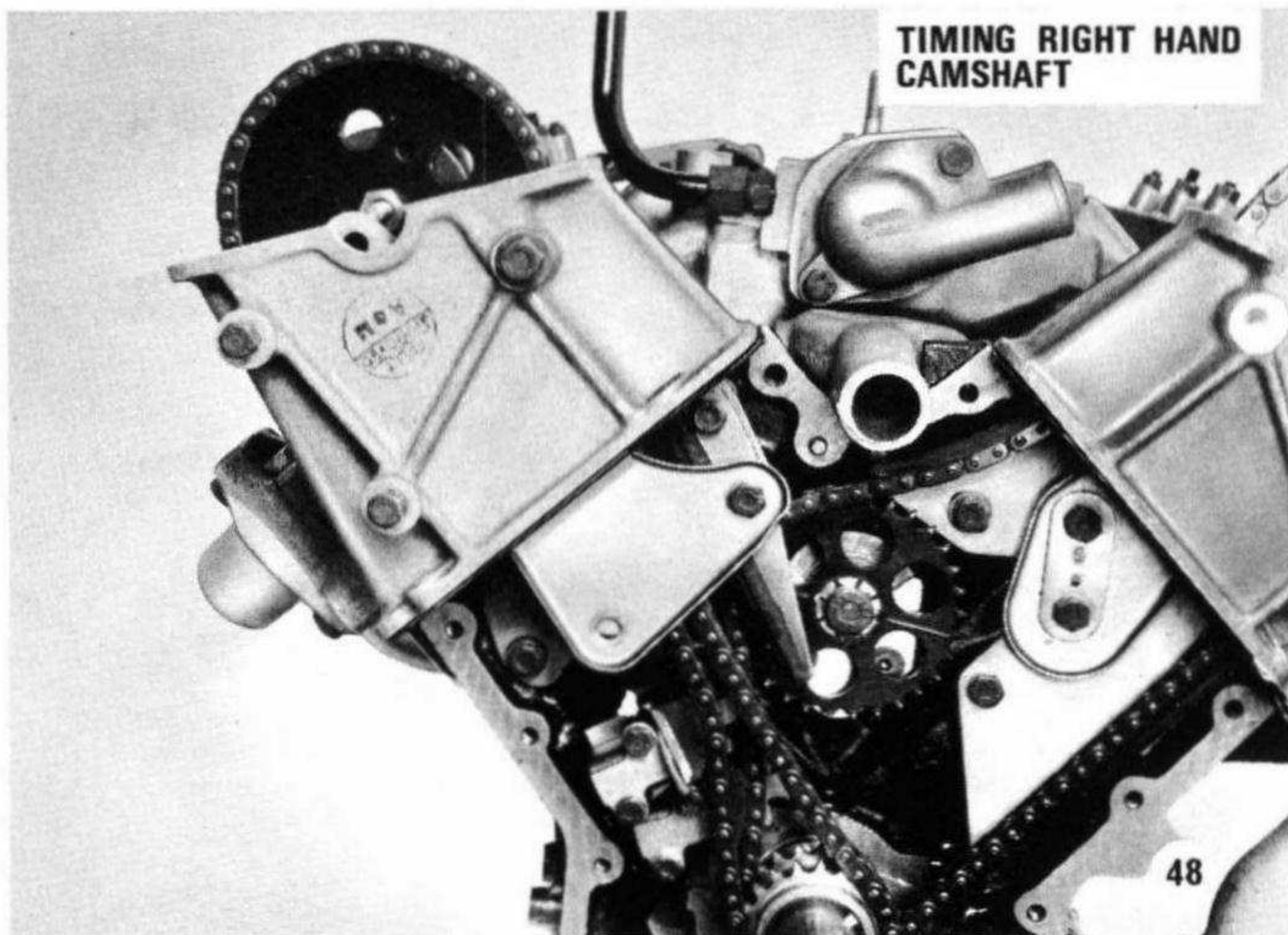

FRAME 48

TIMING THE RIGHT-HAND CAMSHAFT

Remove the bolt securing the left-hand side of the sprocket mounting bracket, leaving the other chain guide bolts loose.

Remove nut securing sprocket to mounting bracket and move bracket to one side.

Rotate the sprocket within the chain, one tooth at a time, until the sprocket securing holes are in line with holes in camshaft flange.

Press sprocket spigot into hole in camshaft flange.

Secure sprocket to camshaft with one bolt and lock tab and tighten to 7–9 lb. ft. (1.0–1.2 kg. m.).

Refit chain guide spacer, move sprocket mounting bracket into the correct position and refit bolt and washer.

Rotate crankshaft until remaining two bolts securing the timing chain sprockets to the camshaft can be fitted.

Return crankshaft to the T.D.C. No. 2 cylinder firing position.

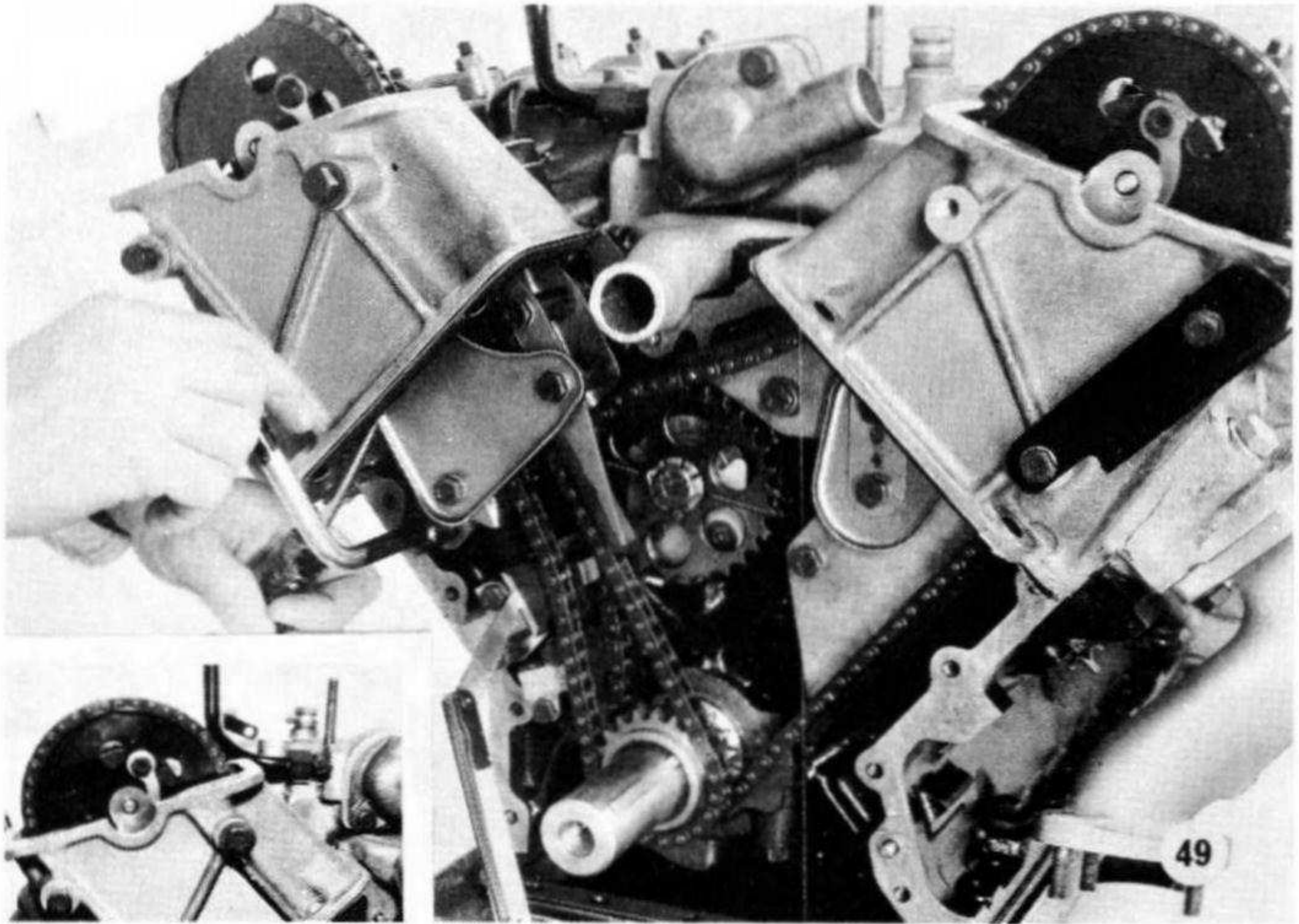

FRAME 49

Remove cardboard from chain tensioner carefully to avoid actuating the unit.
Insert 0.040" (1.0 mm.) shim between the chain tensioner head and body.
Remove all slackness from the chain and tighten the chain guide adjustment bolt.

Tighten chain guide bolts to 18–20 lb. ft. (2.5–2.7 kg. m.).

NOTE: Ensure there is clearance between the thread of the sprocket spigot and the hole in the mounting bracket as shown in inset.

Remove .040" (1.0 mm.) shim.

Ensure chain is running on chain guide rubber.

REFITTING FRONT OIL SEAL



FRAME 50

FRONT OIL SEAL

Press oil seal into the front timing cover with the lip of the seal facing inwards. Using a straight-edge, check that the seal is flush with the outer face of the timing cover.

Lubricate the seal with S.A.E. 140 oil.

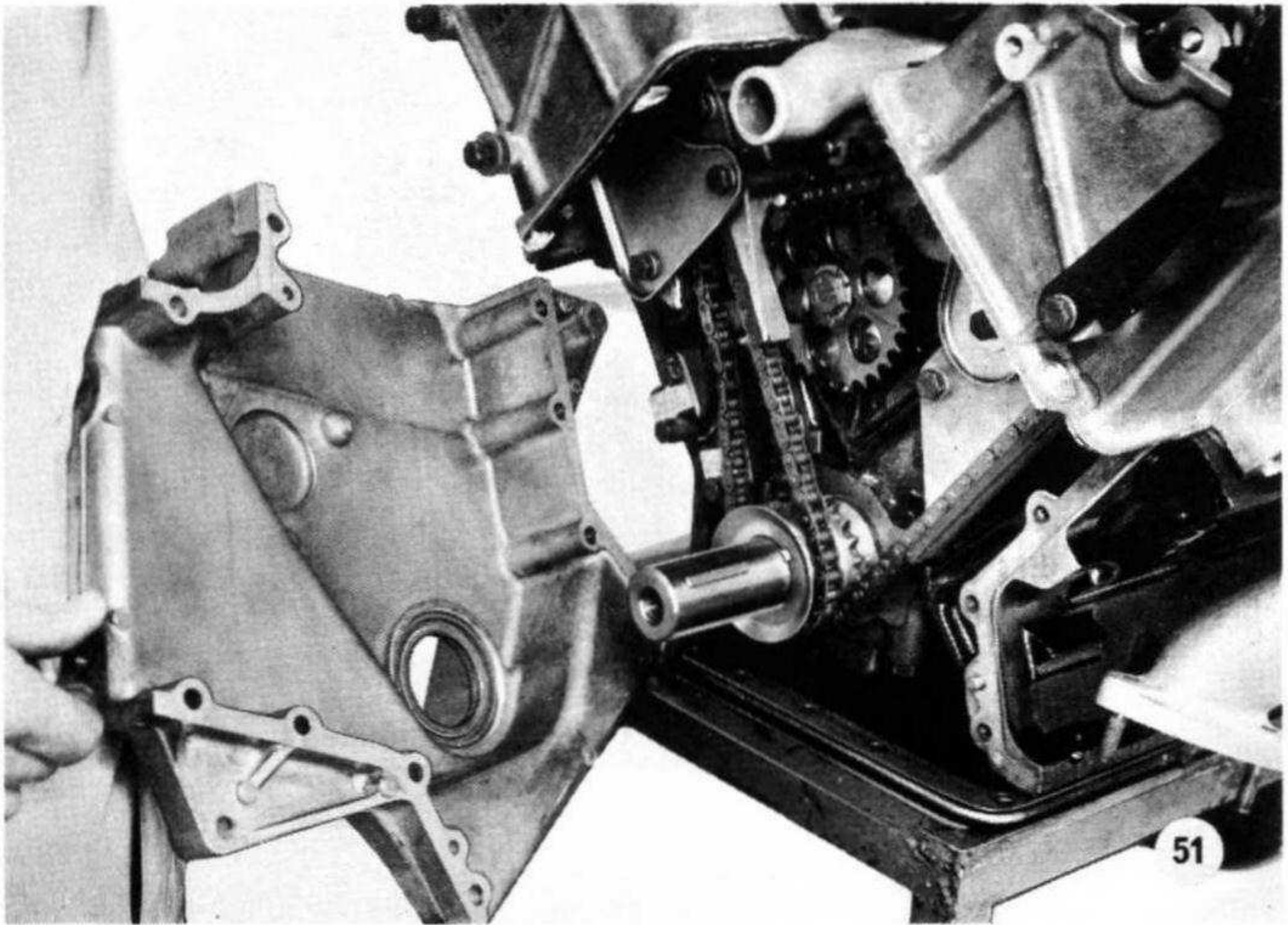

FRAME 51

FITTING FRONT TIMING COVER

Fit three separate front timing cover gaskets to crankcase.

Fit the oil flinger onto the nose of the crankshaft with the dished side facing outwards.

When fitting the timing cover care should be taken not to damage the oil seal on the crankshaft nose. Locate cover on two dowel pins and then place strips of shim steel between the three faces of the cover and gaskets.

This prevents the head and sump gaskets being trapped and damaged.

Remove strips of shim steel before fitting timing cover securing bolts.

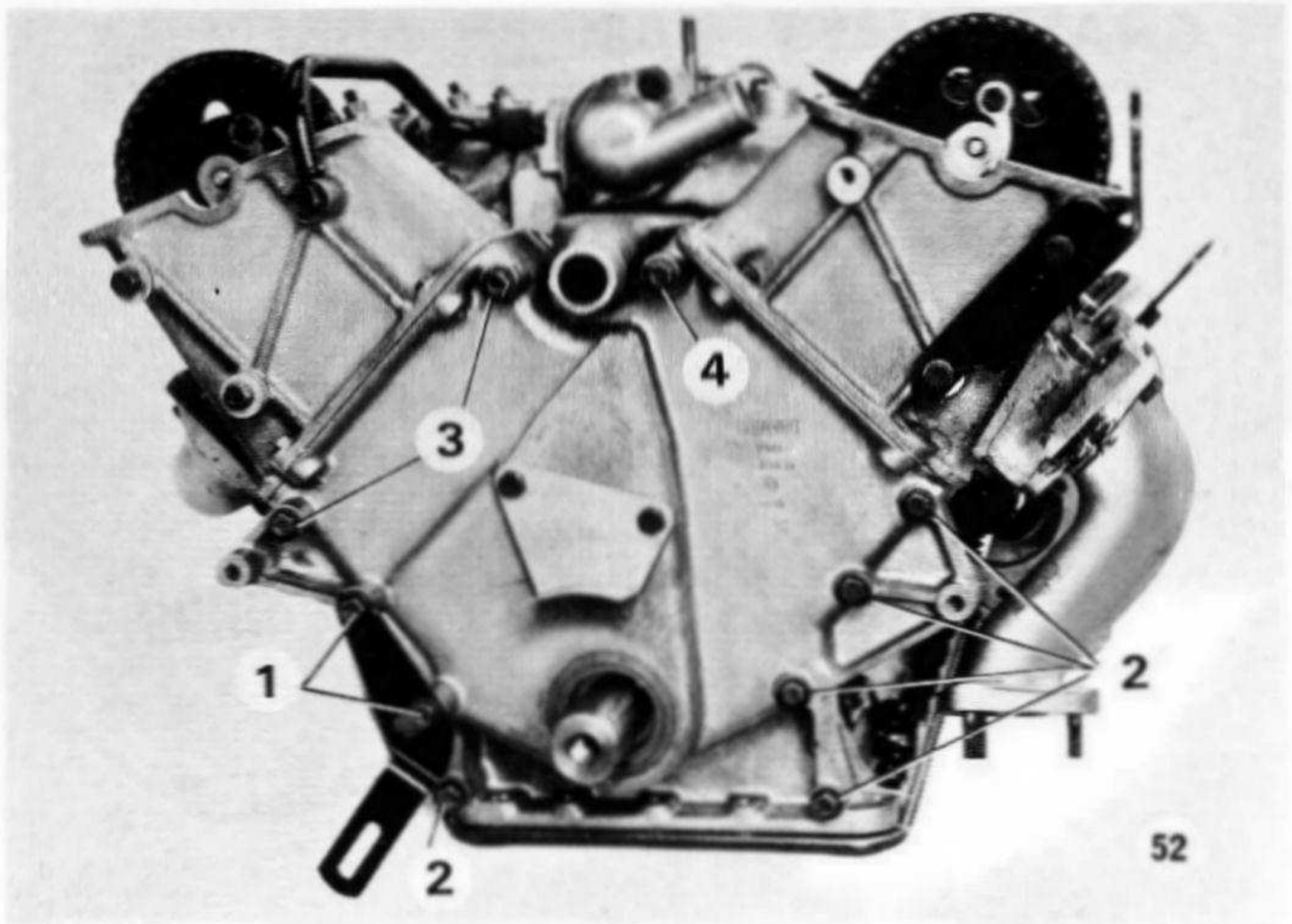

FRAME 52

TIMING COVER BOLTS

Four special bolts with small heads secure the timing cover to the cylinder heads which should be fitted finger-tight.

Fit ten bolts of various lengths which secure front timing cover to cylinder block.

The alternator bracket is fitted to the two bolts shown in the illustration.

The different bolt shank lengths are given below together with their location number:

1. $3\frac{5}{8}$ " (9.2 cm.) long
2. $1\frac{3}{4}$ " (4.7 cm.) long
3. $3\frac{1}{2}$ " (8.9 cm.) long
4. 3" (7.6 cm.) long

Before tightening the 14 bolts to 16–20 lb. ft. (2.2–2.7 kg. m.), fit the remaining five bolts securing the front of the sump to the timing cover. Tighten all sump bolts to 16–20 lb. ft. (2.2–2.7 kg. m.).

CRANKSHAFT DAMPER ASSEMBLY

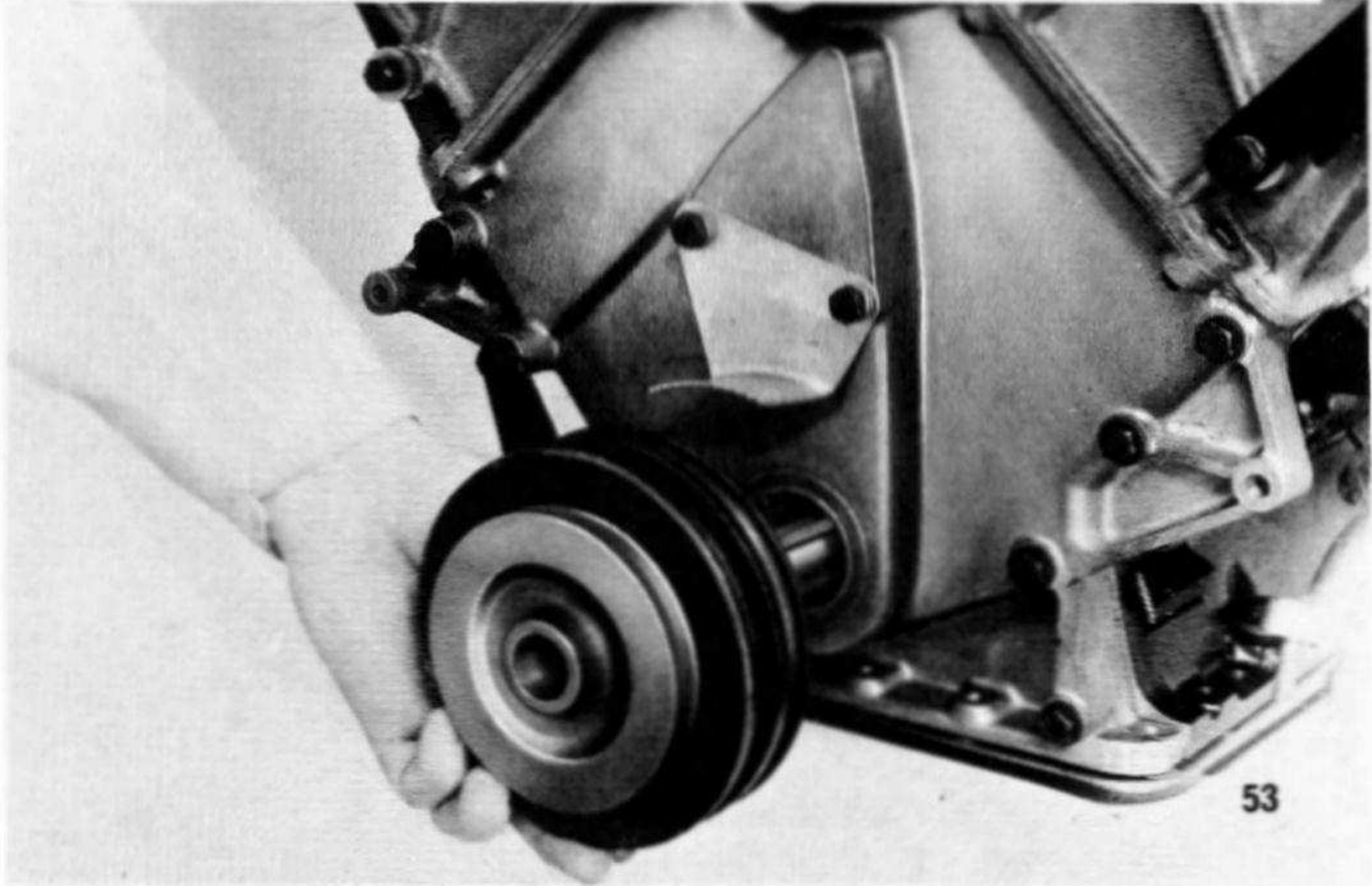

FRAME 53

FITTING THE DAMPER ASSEMBLY

Fit the Woodruff key to the nose of the crankshaft.

NOTE: The small pulley fitted to the front of the damper assembly is located by a dowel.

Slide the damper assembly and pulley onto the crankshaft, taking care not to damage the oil seal in the timing cover.

NOTE: The damper assembly may be removed using a universal puller.

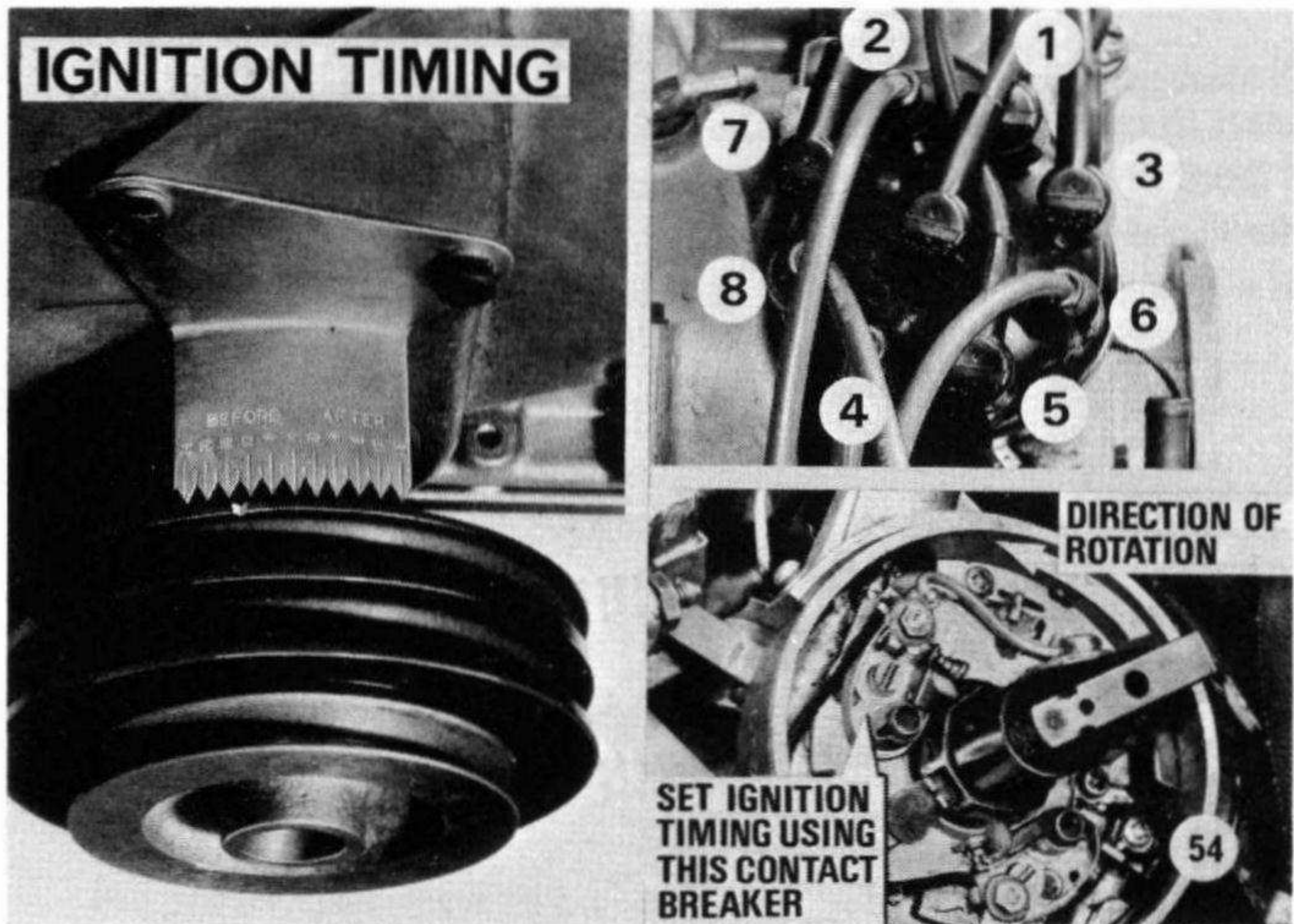

FRAME 54

IGNITION TIMING

The distributor has two sets of points to allow a longer closed period (dwell angle) than would be possible if only one pair of contacts were used.

The rotor arm moves in an anti-clockwise direction and the contact breaker farthest from the vacuum advance unit operates first, followed by the second pair of contacts.

To set the ignition timing proceed as follows :

1. Rotate the engine and with each contact breaker in turn on the peak of the cam lobe adjust to 0.014"–0.016" (0.35–0.40 mm.) gap in the normal way. Dwell Angle $29\frac{1}{2}$ – $33\frac{1}{2}$ °.
2. Rotate engine backwards for at least half a revolution and then rotate forwards until the timing mark on the damper is aligned with 14° B.T.D.C. on the scale.

NOTE: ENGINE FIRING No. 2 CYLINDER.

3. Disconnect the distributor negative wire from the coil and connect a low wattage 12-volt bulb between the negative wire and the live terminal of the battery.

4. Rotate distributor body until **SECOND** set of contact breaker points start to open, i.e. timing lamp starts to glow.
5. Tighten two distributor securing bolts using special tool No. S 349.
6. Refit distributor cap and leads.
- 7 Refit eight champion N 11Y sparking plugs.

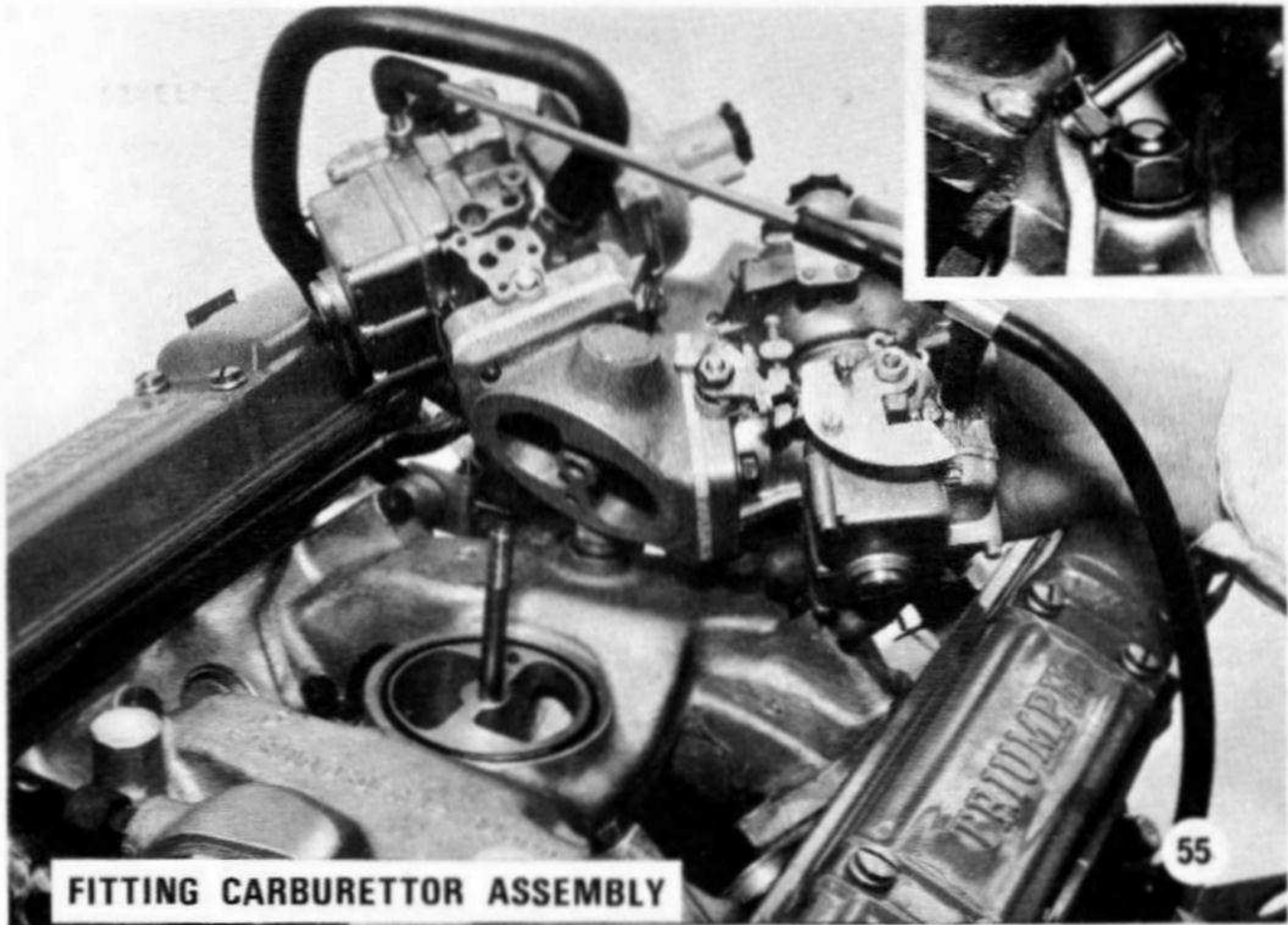

FRAME 55

PART 6

REFITTING CARBURETTORS

The carburettors are secured to the carburettor housing by four nuts and washers. Gaskets are fitted between the carburettors and housing.

The carburettors and housing are secured to the inlet manifold by a single stud, fibre washer, plain washer and nut.

NOTE: It is most important that the fibre washer is fitted, and in good condition, to form a seal. If the fibre washer is not fitted, air may leak into the inlet manifold causing a lumpy idle condition.

An 'O' ring is used to form a seal between the carburettor housing and inlet manifold.

Removal of a single carburettor will be easier if both carburettors and housing are removed as an assembly from the inlet manifold after first removing the vacuum union on the right-hand carburettor.

**STROMBERG
17S CDS
CARBURETTOR**

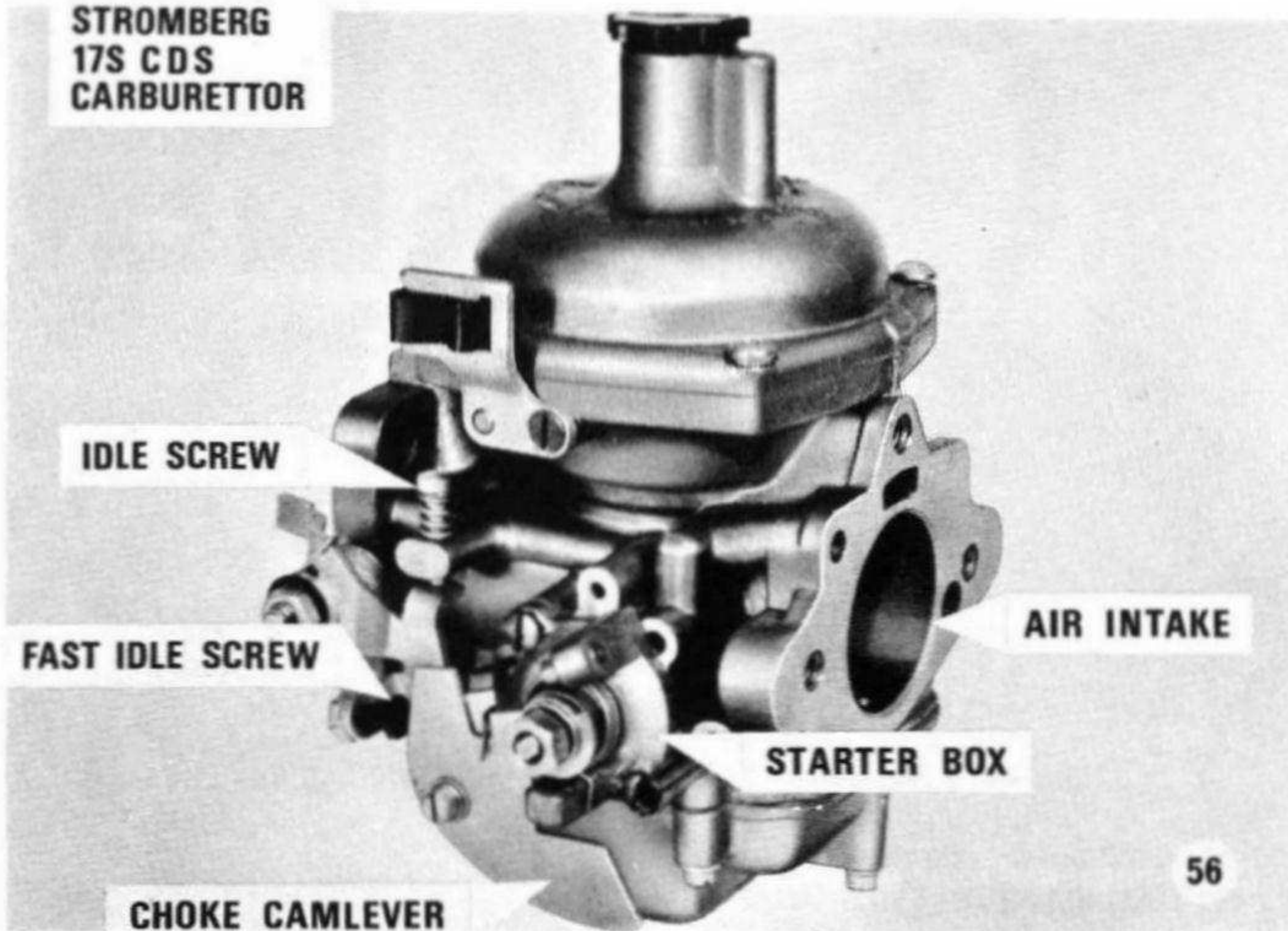

FRAME 56

STROMBERG CARBURETTOR SERVICING

The Stromberg carburettor shown in the illustration has the following new features.

Air/fuel mixture is adjusted by special tools inserted through the top of the carburettor.

The needle, which is spring-loaded, is biased towards the air cleaner elbow.

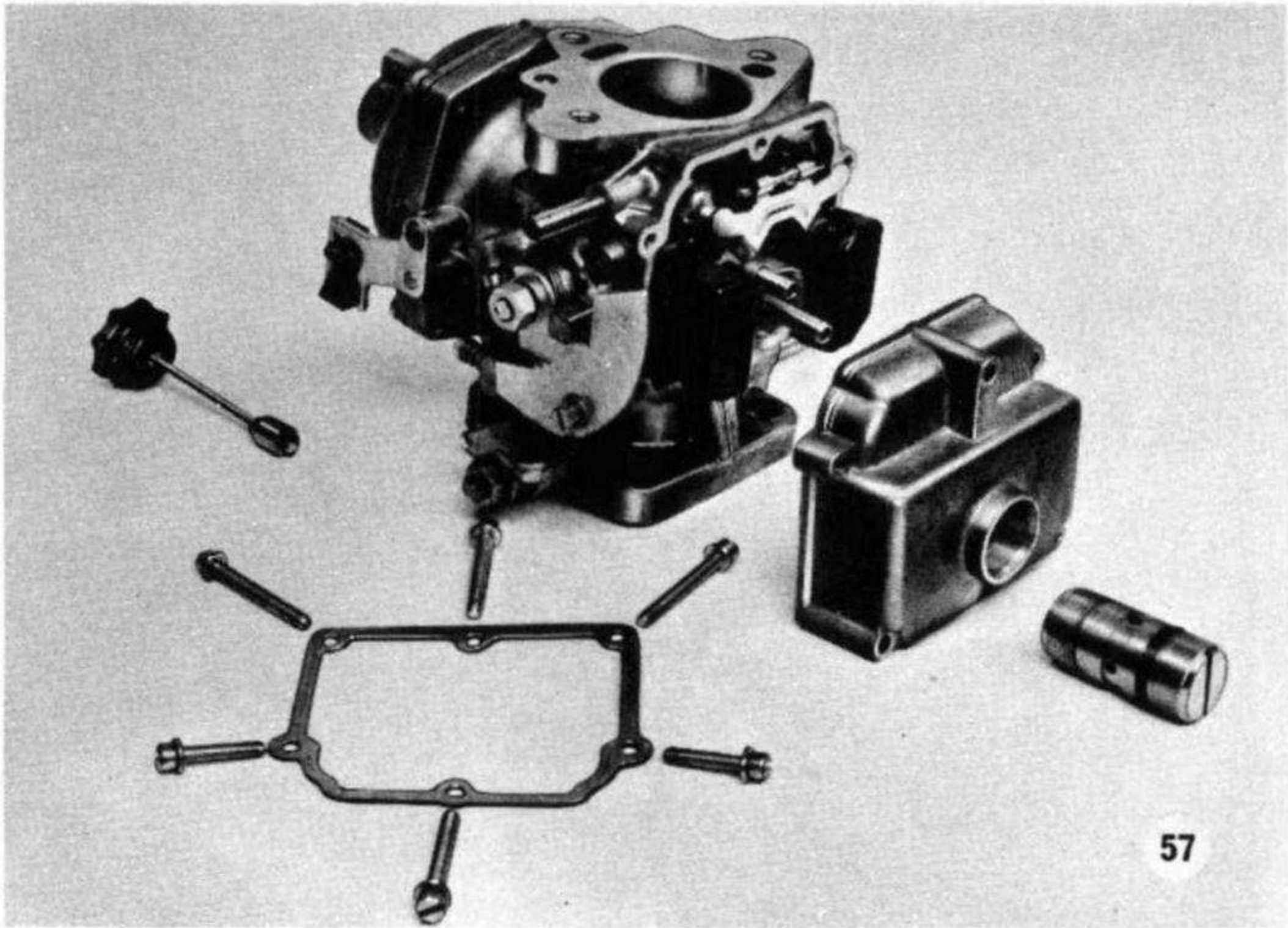

FRAME 57

FLOAT-CHAMBER ASSEMBLY

Service each carburettor separately to avoid interchanging components.

1. Remove damper from top of carburettor and drain off from air valve guide tube.
2. Remove brass plug in centre of float-chamber and drain fuel from system.
3. Remove six float-chamber attachment screws and carefully remove float-chamber and gasket.

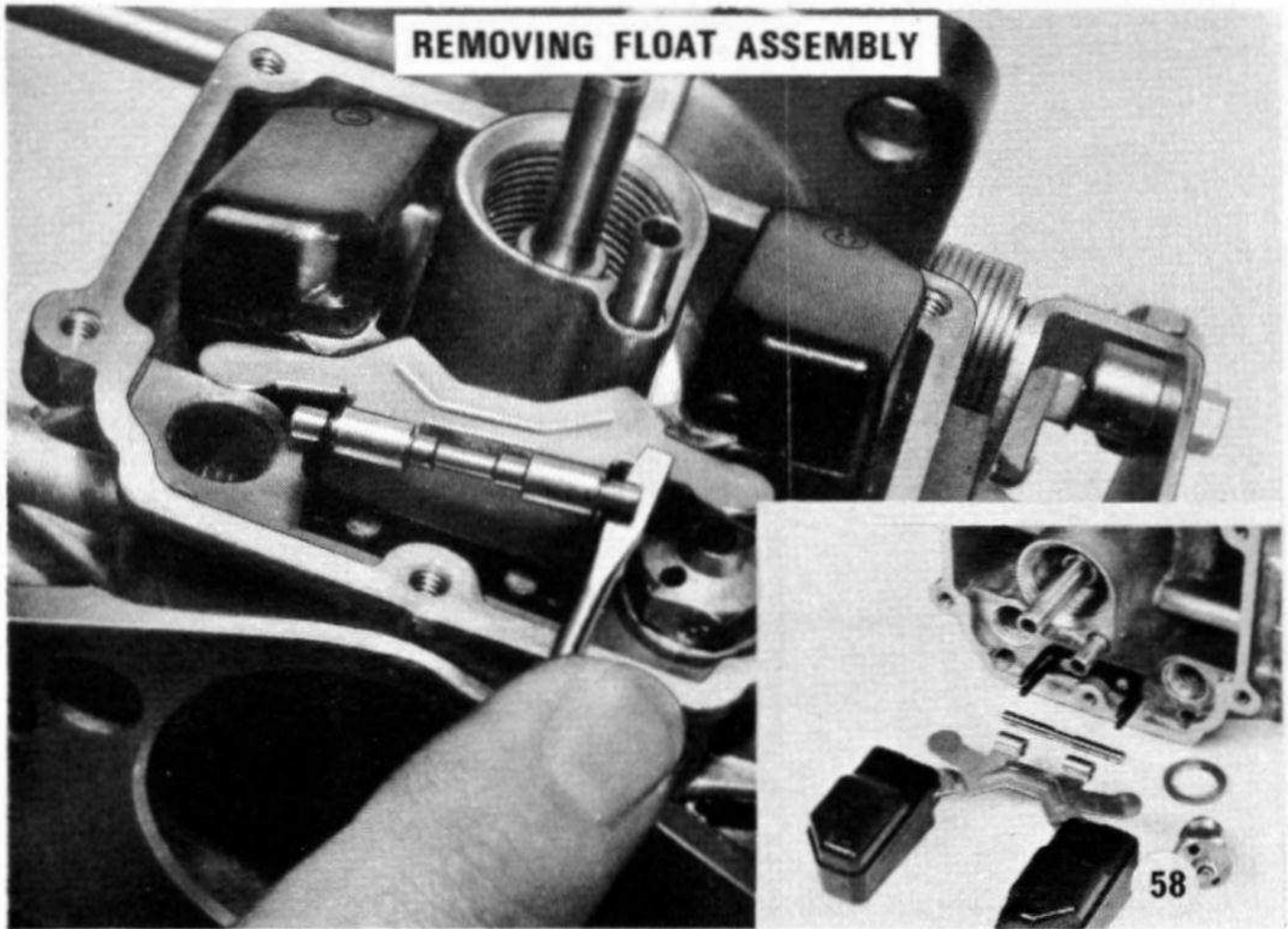

FRAME 58

4. Remove floats by carefully levering up at either end of float pivot pin as shown. Avoid any force which might distort float assembly as this would upset fuel level.
5. Remove float-chamber needle valve and washers.

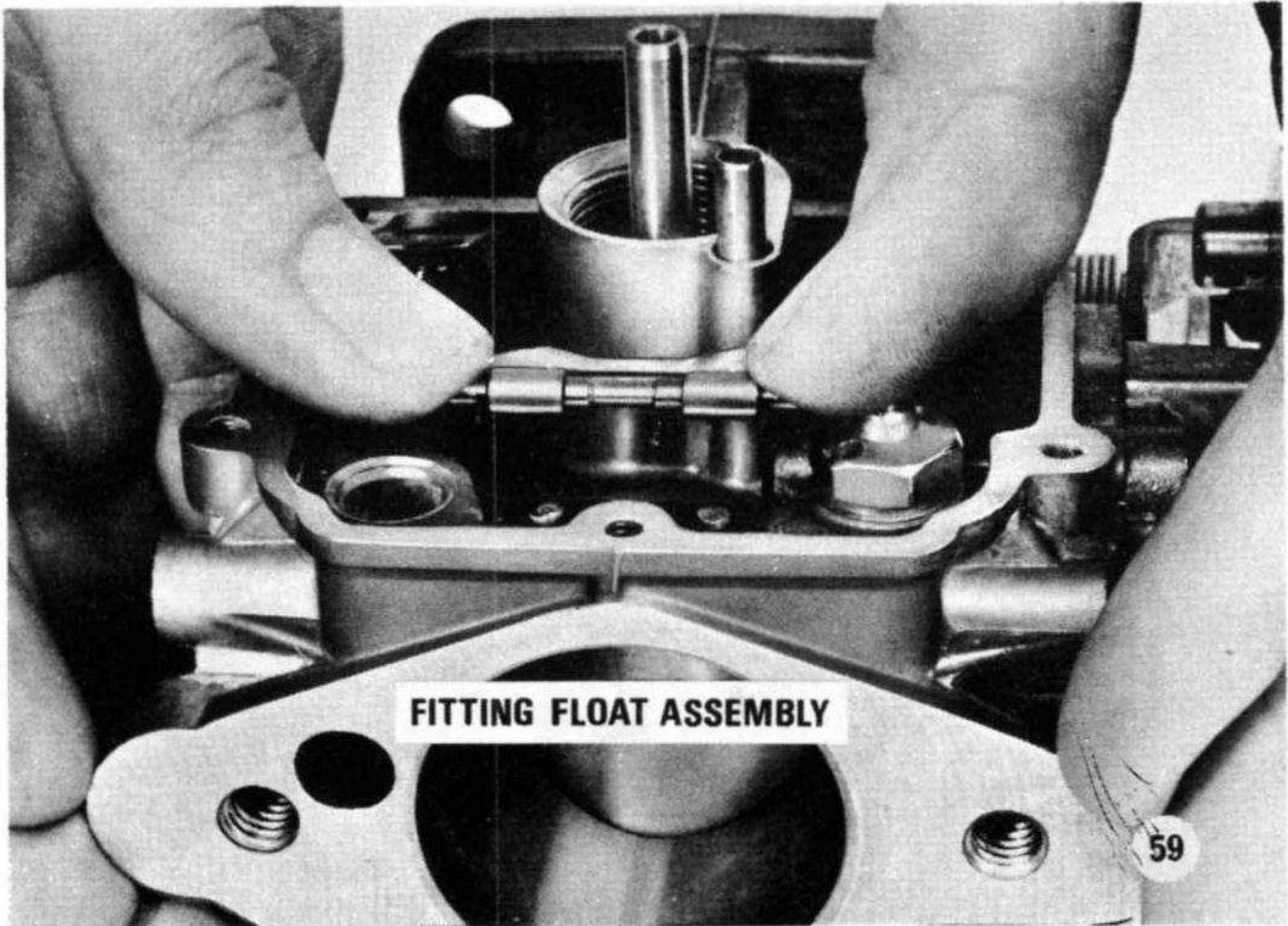

FRAME 59

Wash all parts thoroughly and dry with compressed air, NOT RAG.

Check needle valve seating.

Fit new float-chamber needle valve washer, screw needle valve securely into carburettor body.

Replace float by pressing on ENDS of float pivot pin. To prevent distortion of pivot pin avoid pressure at the centre.

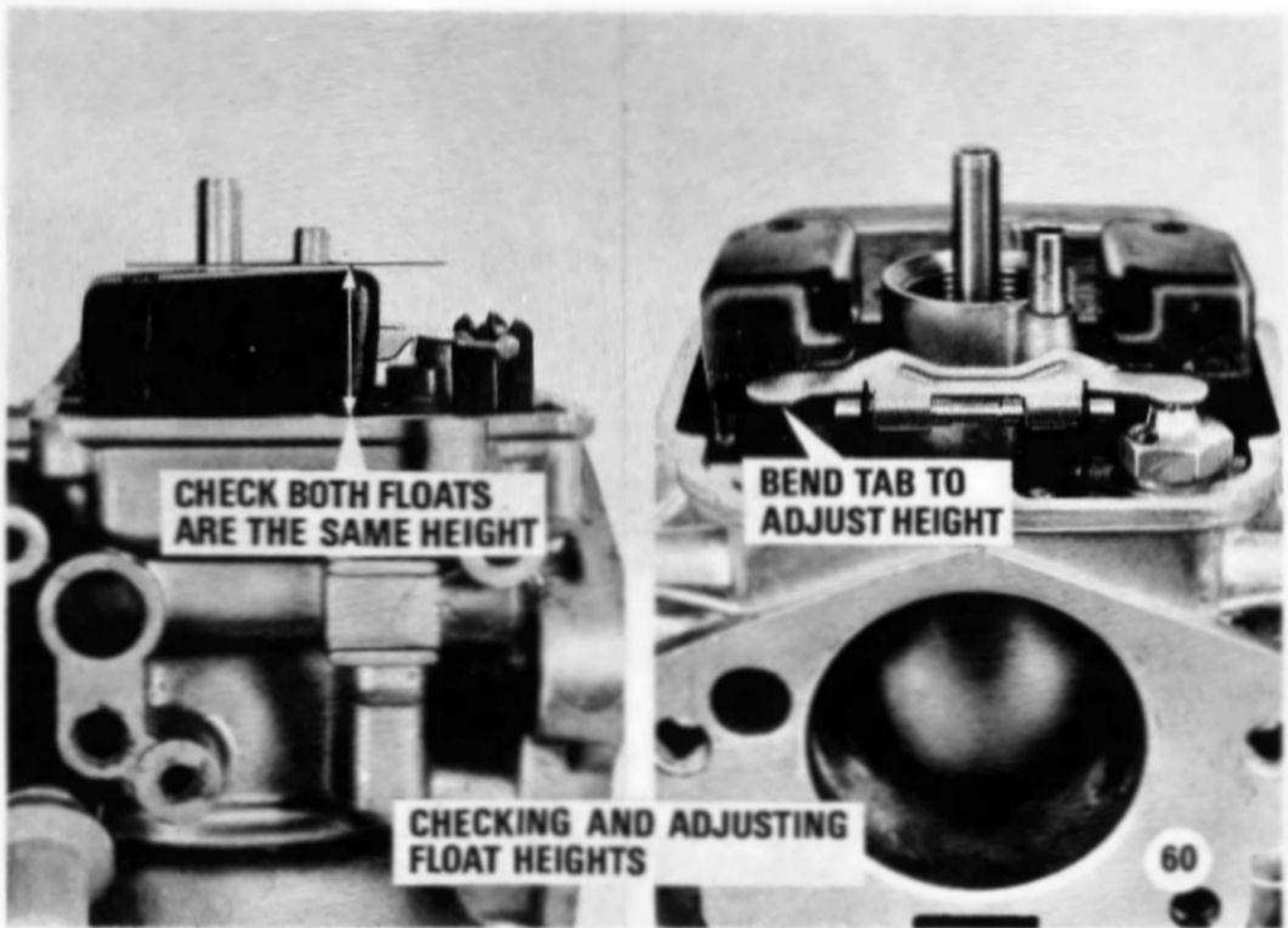

FRAME 60

To ensure correct fuel level, check the distance between float-chamber flange without gasket, to highest point of each float. Correct measurement 16·0 to 17·0 mm.

NOTE:

- A. The height of both floats must be the same.
- B. If adjustment is necessary, bend the tab over the needle valve until correct measurement is obtained, ensuring tab contacts needle at right angles to prevent any possibility of sticking.

For speed and accuracy it is advisable to make a gauge to check float height.

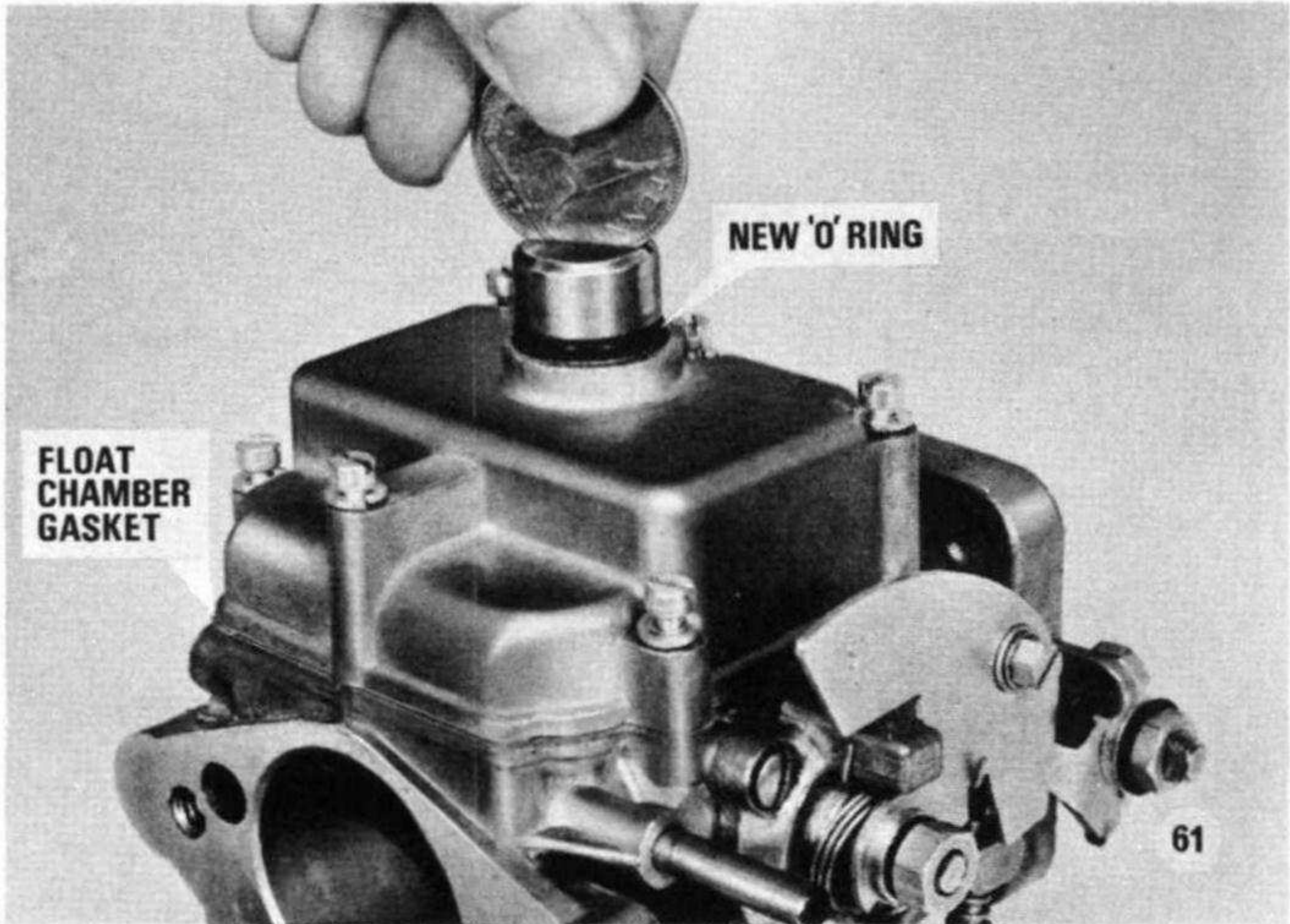

FRAME 61

Fit new float-chamber gasket, refit and secure cover with six attachment screws; at this stage leave screws finger-tight.

Fit new 'O' ring to pump and screw plug through bottom of float-chamber into jet housing.

Tighten the six float-chamber screws.

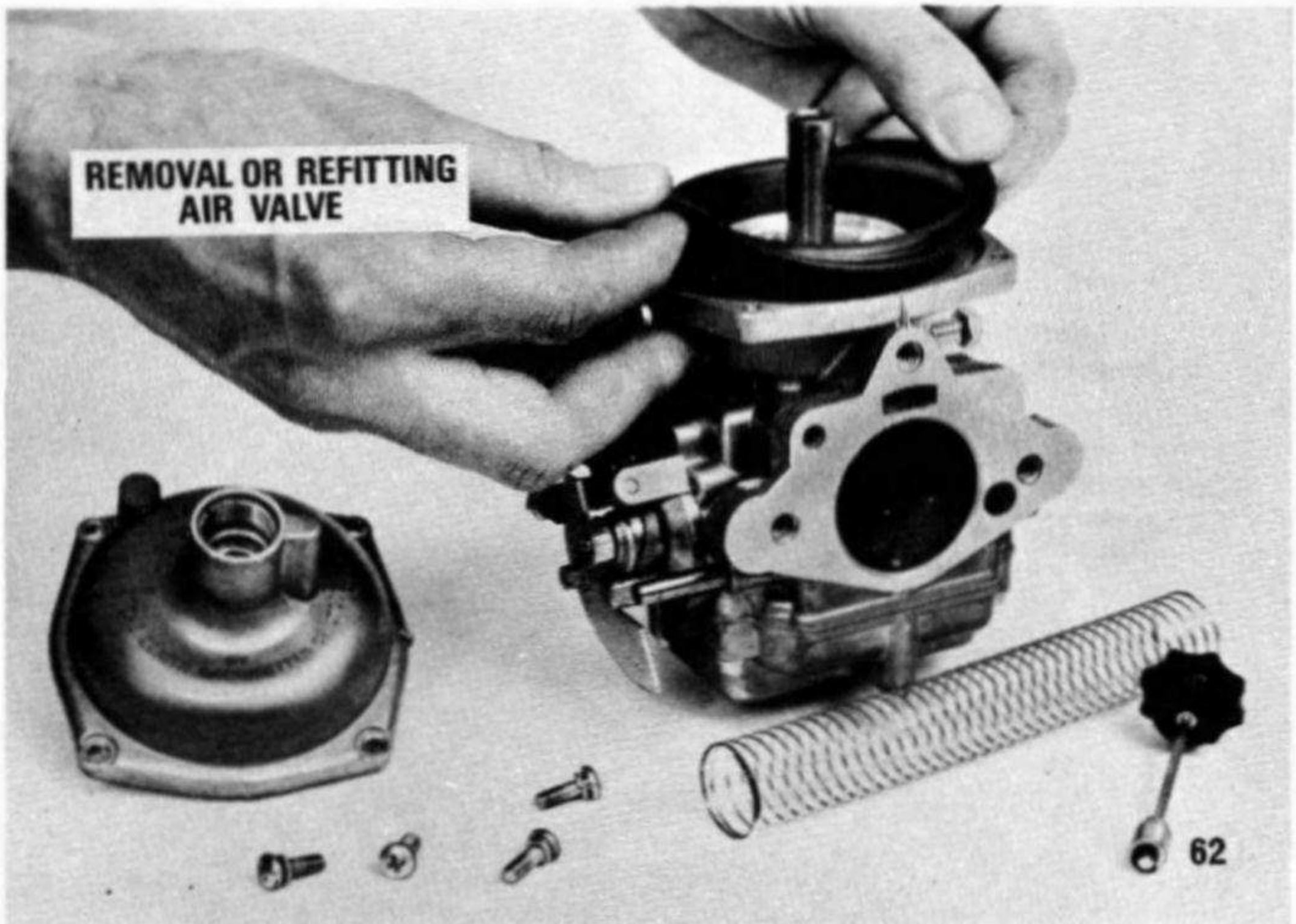

FRAME 62

AIR VALVE ASSEMBLY

Remove air valve damper.

With the special-type screwdriver remove the four cover screws.

Before lifting cover, note position of bulge on housing neck. It faces towards air intake.

Remove cover and spring.

It is **IMPORTANT** to lift out air valve assembly by holding diaphragm as shown. Avoid touching air valve stem, as moisture from the fingers will cause corrosion.

CHANGING DIAPHRAGM

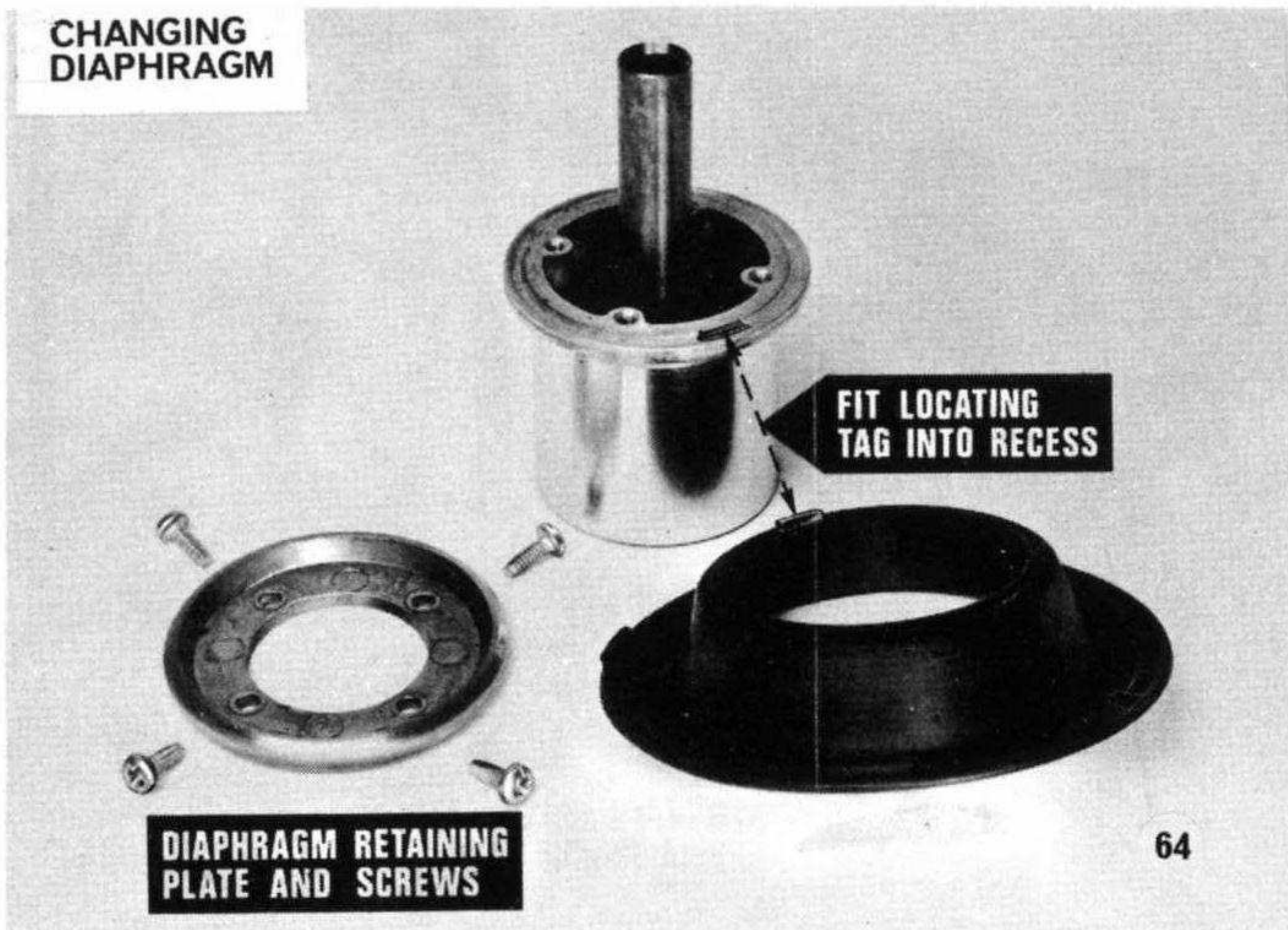

FRAME 64

CHANGING DIAPHRAGM

1. Remove screws with the special-type screwdriver and remove retaining plate.
2. Lift off diaphragm.

FITTING NEW DIAPHRAGM

1. Position moulded tag in air valve recess as shown.
2. Fit retaining plate and four screws finger-tight.
3. Check diaphragm is seating properly all round.
4. Tighten screws fully.

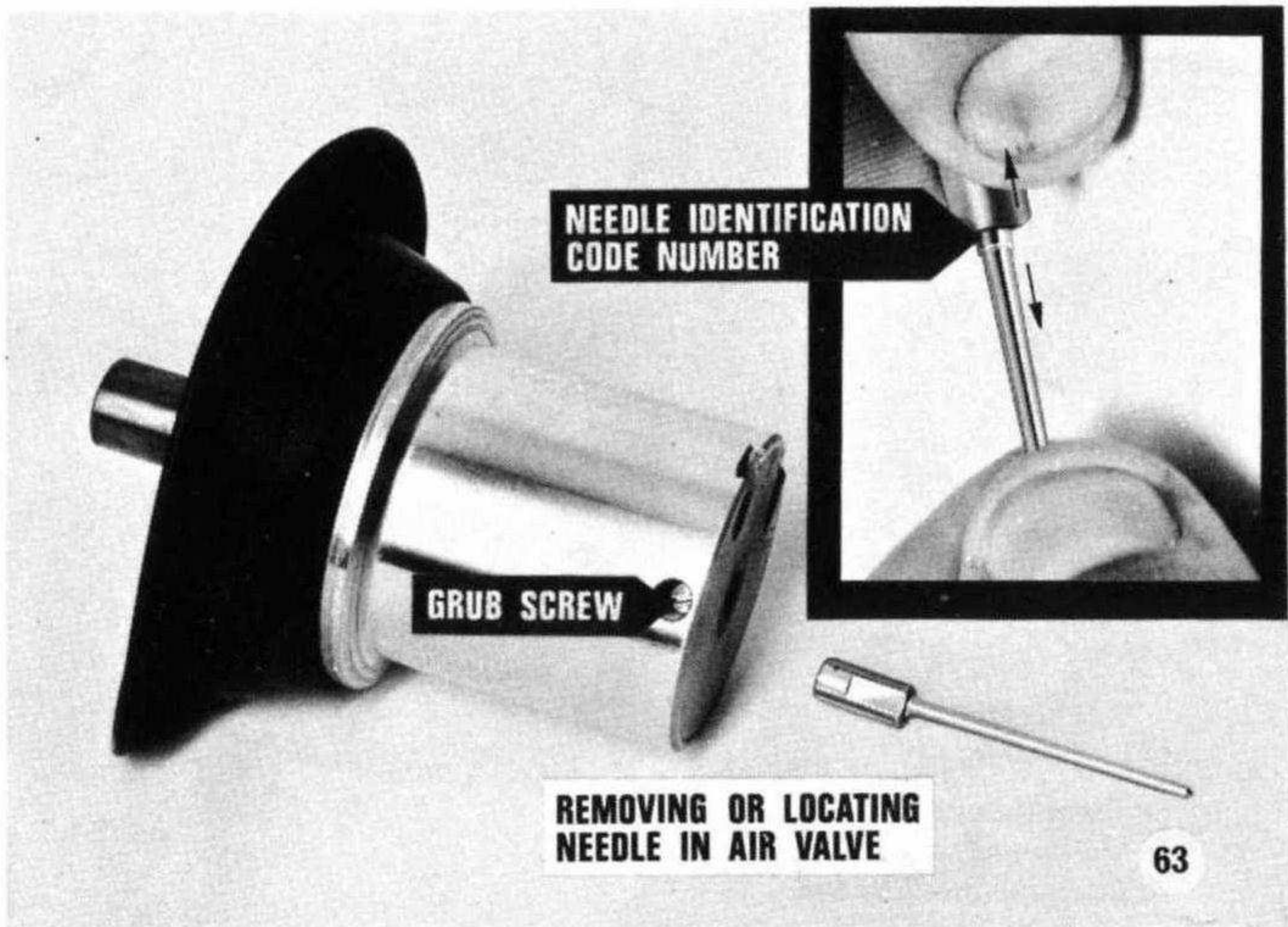

FRAME 63

REMOVING NEEDLE FROM AIR VALVE

Slacken grub screw, and using the special tools in the air valve tube unscrew spring-loaded needle assembly and keep in a safe place while changing diaphragm.

NEEDLE IDENTIFICATION

The code number is found on the shank of the needle. Pull needle against spring pressure as shown by arrows to read code (see inset).

NOTE: The needle and its spring-loaded housing are an assembly and cannot be obtained separately.

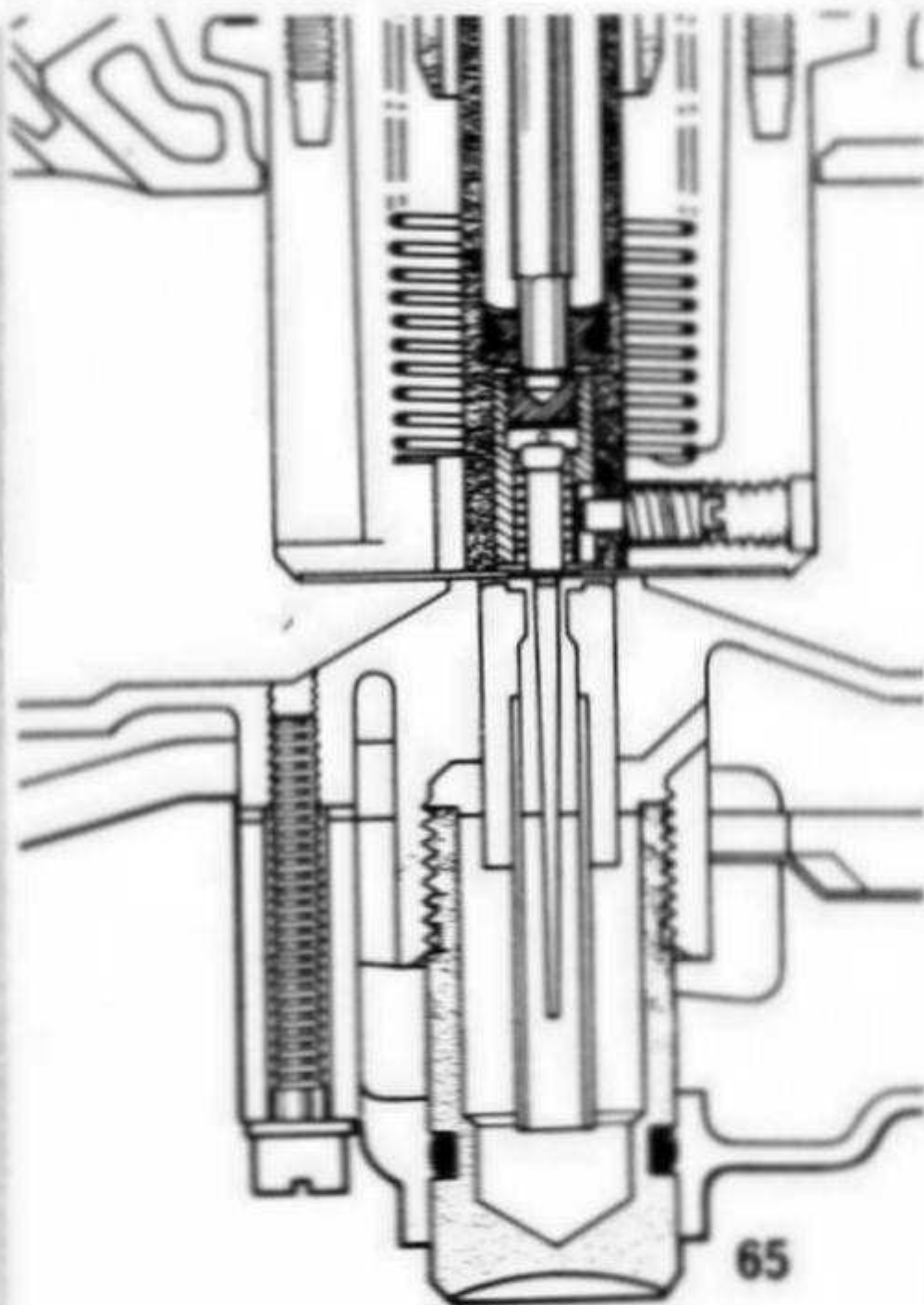
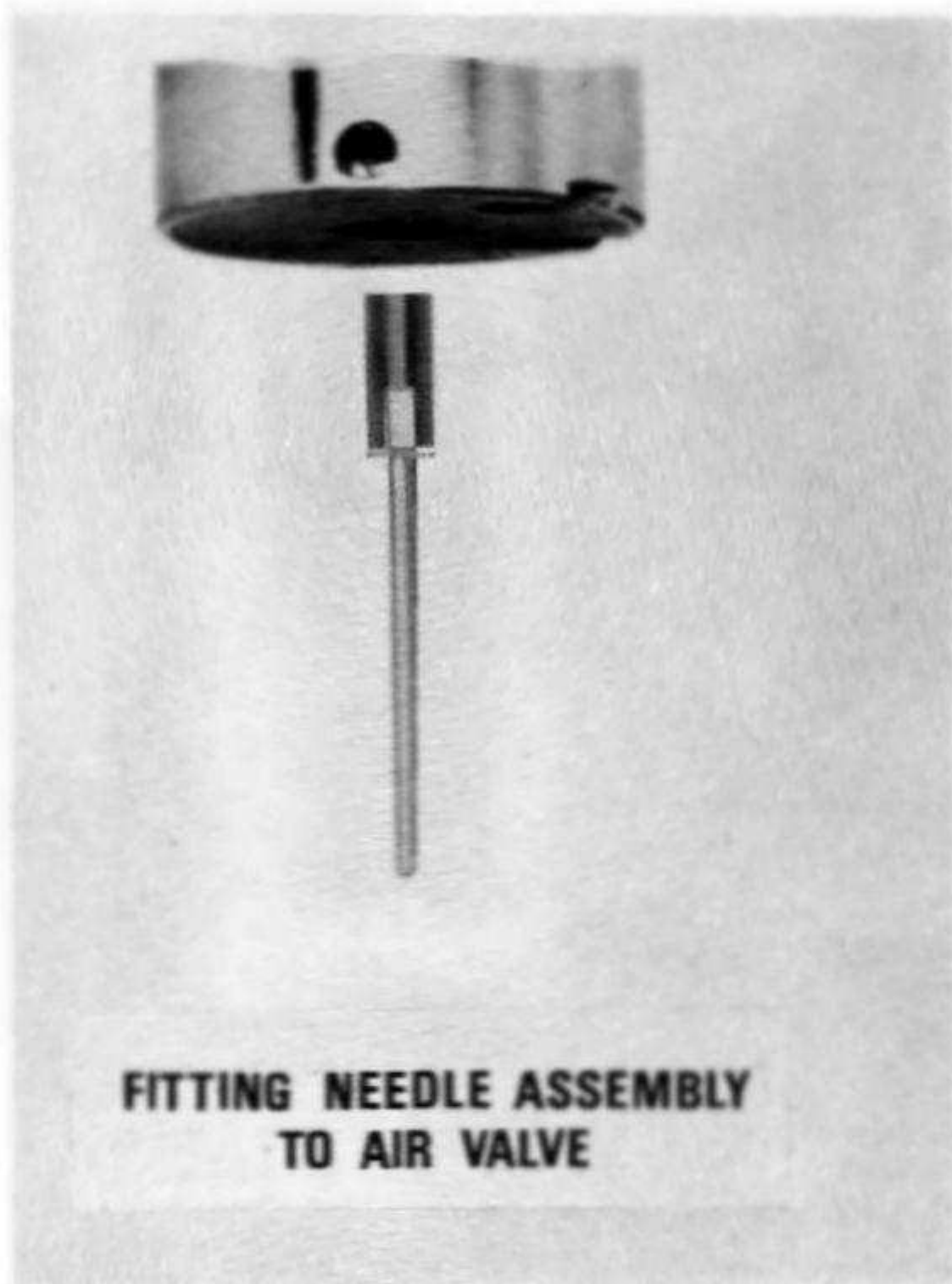

FRAME 65

FITTING NEEDLE ASSEMBLY TO AIR VALVE

1. Check needle assembly spring action (when fitted the needle bias faces the air cleaner elbow).
2. Offer up the needle assembly to the air valve.
3. Fit the special needle adjustment tools in the air valve tube and turn the tool approximately one-and-a-half turns in a clockwise direction.
4. Continue to rotate the needle until the slot in the needle housing is in line with the air valve grub screw. Fully tighten the grub screw.
5. The grub screw does not hold the needle in position, but acts as a locating peg and prevents the needle assembly from rotating during adjustment.

**VERY IMPORTANT TO
HOLD NEEDLE IN
VERTICAL POSITION**

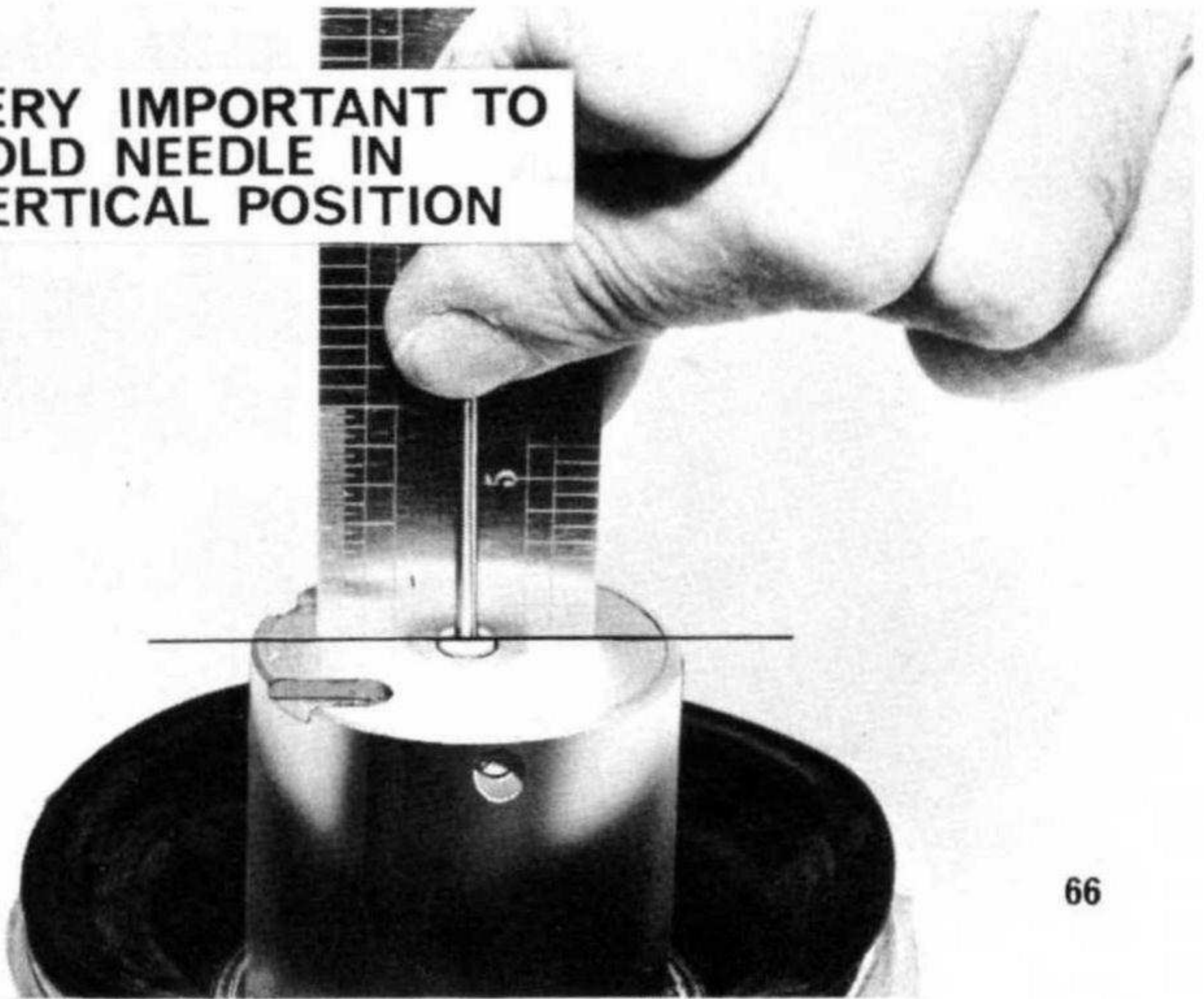

FRAME 66

CORRECT POSITIONING OF NEEDLE

It is most important that the needle is adjusted to the optimum condition before fitting to the carburettor and final adjustment using an air fuel meter.

Using the tools previously described, adjust the needle until the face of the nylon washer is below the surface of the air valve.

Hold a steel rule in the position shown above with the needle against it and held in the vertical position against spring pressure.

Adjust the needle upwards until the face of the nylon washer just contacts the steel rule.

FITTING AIR VALVE ASSEMBLY

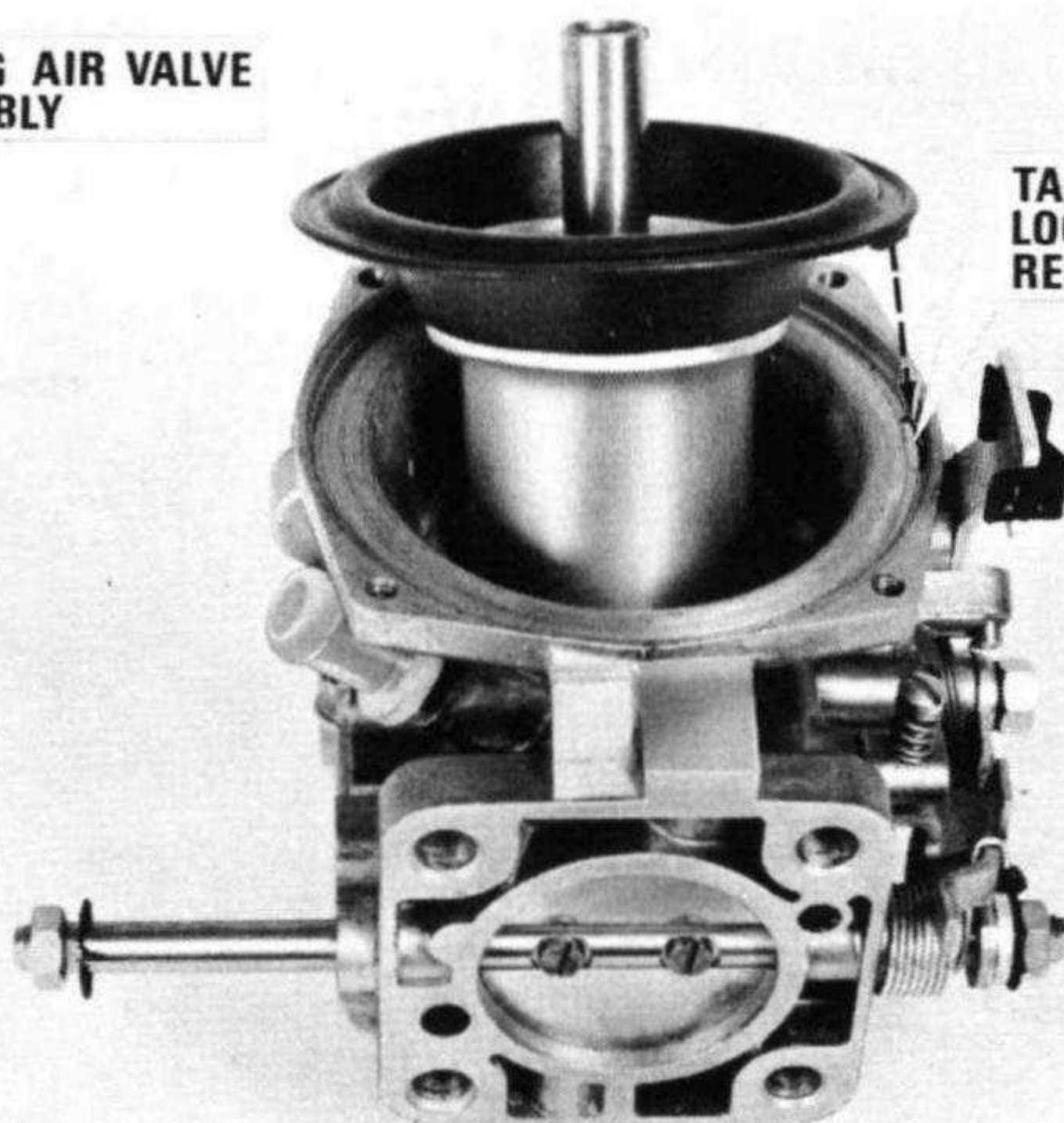

TAG MUST
LOCATE IN
RECESS

67

FRAME 67

FITTING AIR VALVE ASSEMBLY INTO CARBURETTORS

1. Hold assembly by diaphragm as described in Frame 62. Avoid contaminating valve stem by unnecessary handling.
2. Carefully insert needle end into jet.
3. Lower assembly into position.
4. Check that diaphragm tag is located in recess as shown and beaded edge is resting in groove evenly all the way round.
6. Fit air valve cover and evenly tighten the four screws with the special screwdriver.
NOTE: If screws are not fully tightened it is possible for the air valve to stick.
7. Fill up with correct grade of oil to within $\frac{1}{4}$ " (.6 mm.) of top of damper tube and refit damper.

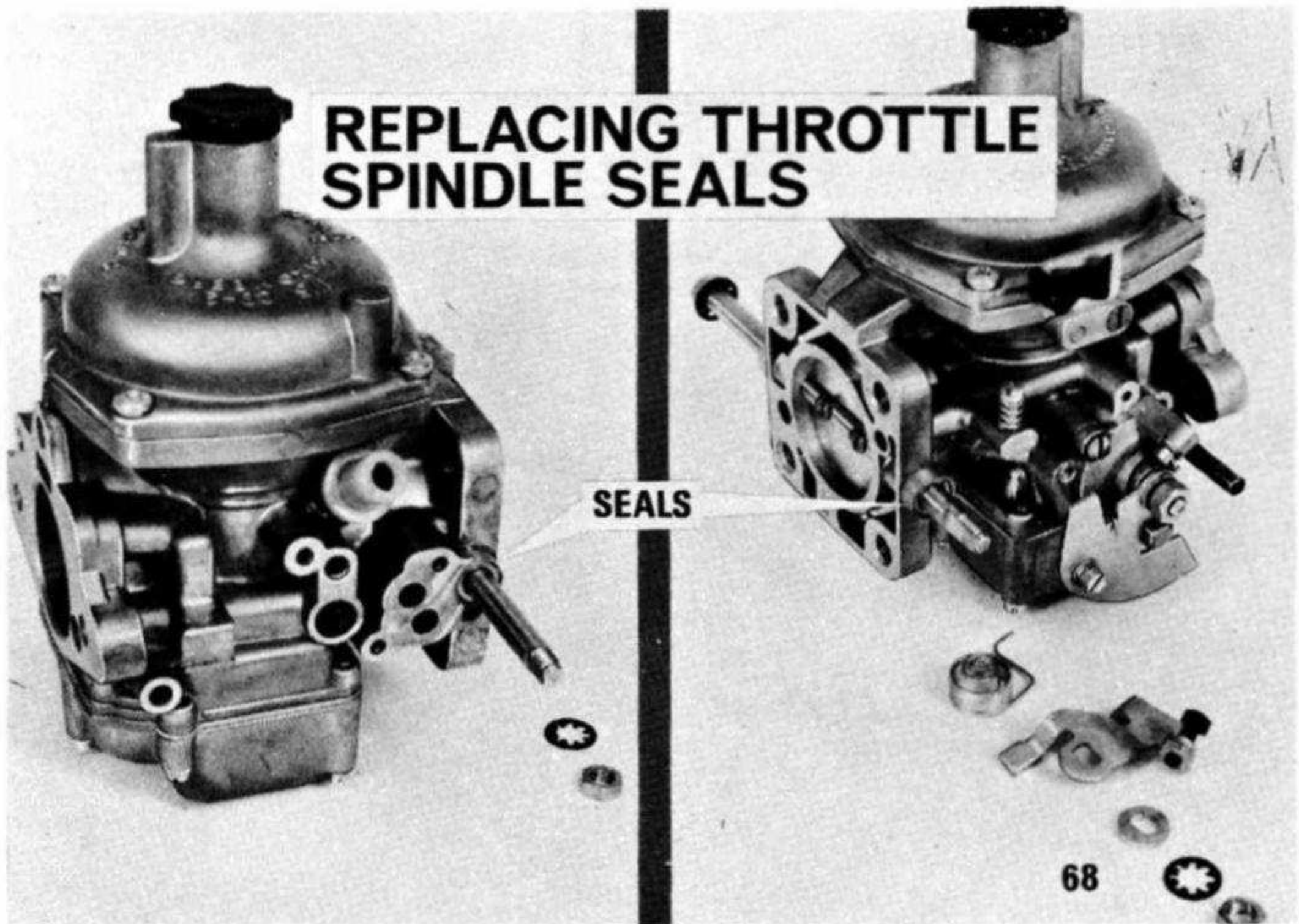

FRAME 68

REPLACING THROTTLE SPINDLE SEALS

Remove throttle spindle lever assembly (right-hand picture).

Remove throttle plate.

Remove throttle spindle seals by prising out with a screwdriver.

Press new seals into position.

Assemble throttle spindle lever assembly.

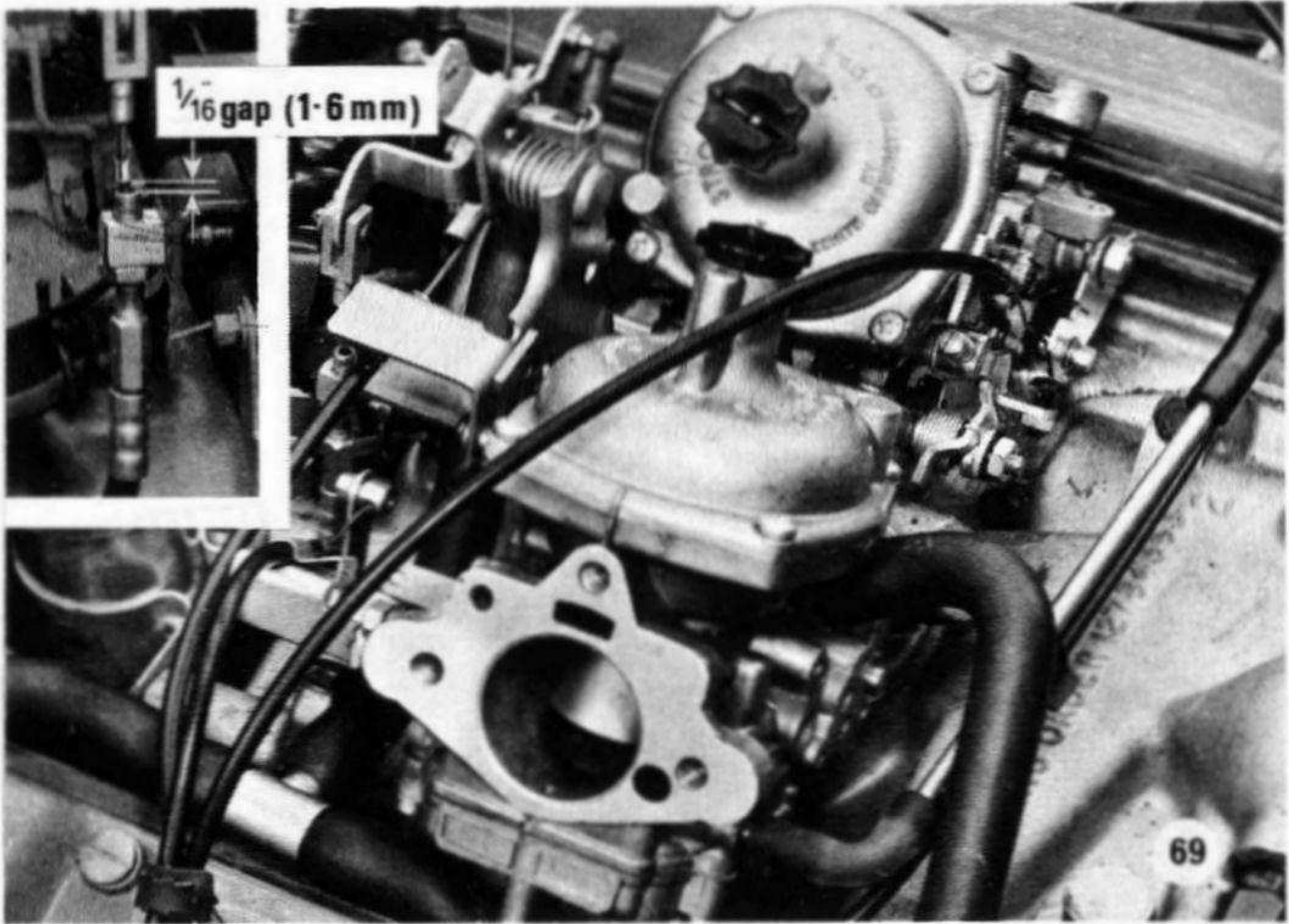

FRAME 69

The carburetors, choke and accelerator cables are shown in the illustration together with their respective clips and attachment points.

The inset shows $\frac{1}{16}$ " (1.6 mm.) gap between the stop and the cable adjustment screw on the automatic transmission 'kick down' cable.

CHOKE CAM-LEVER POSITIONED FOR FAST-IDLE ADJUSTMENT

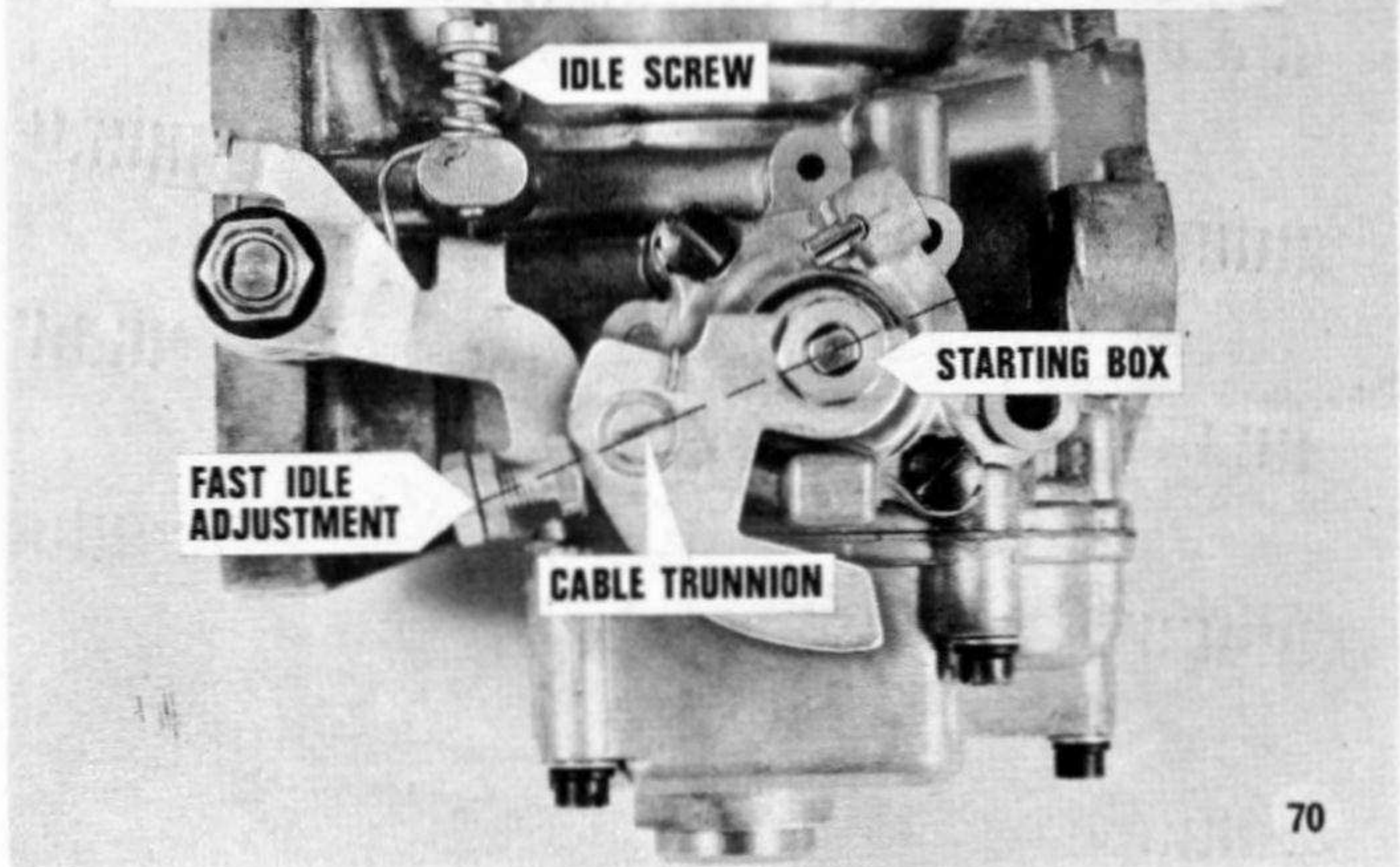

FRAME 70

FAST IDLE ADJUSTMENT

(ENGINE AT NORMAL RUNNING TEMPERATURE)

Before starting any adjustments check that the choke is fully in on the facia and the choke cam against the stop on both carburettors.

Pull out choke control until the cable trunnion is in line with the fast idle adjusting screw and centre of starting box as shown.

Initially, set fast idle screw so that it just touches the cam.

Start engine and adjust choke fast idle screw on carburettor to give an engine speed of 1,100–1,300 r.p.m.

Tighten locknut and check engine speed.

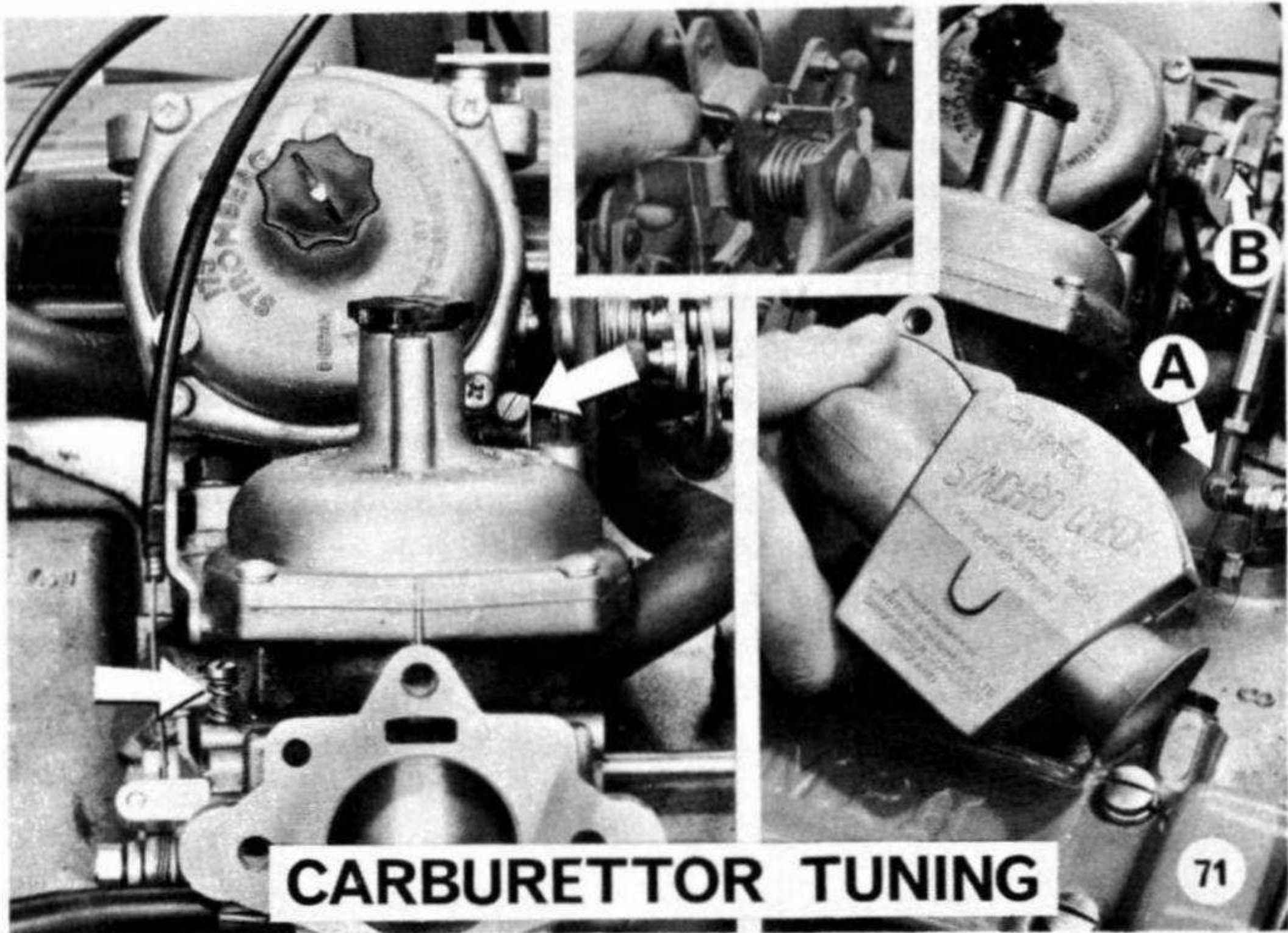

FRAME 71

CARBURETTORS

INITIAL TUNING

Ensure there is sufficient 'free play' in the throttle cable to allow the carburettor butterfly levers to fully return to the stops.

Start engine, disconnect the adjustment link rod 'A' from the carburettor spindle bell-crank.

Use air balancing equipment to check for equal breathing on both carburetors. Adjust the slow-running screws until equal breathing and an idling speed of 600–650 r.p.m. is obtained.

Slacken adjustable link rod ball end locknut and rotate ball assembly until the shank of the ball end lever lines up with the hole in the bell-crank lever.

NOTE:

When fitting ball end no increase in engine speed is permissible as this would upset the carburettor air-flow balance.

Secure ball end to bell-crank and tighten locknut on link rod.

It is essential that clearance is maintained between the accelerator cable quadrant arm and the link rod quadrant at 'B'.

Increase engine speed to 1,000 r.p.m., then 1,500 r.p.m. At each of these speeds check for equal breathing on both carburettors.

Failure to achieve this condition will indicate faulty assembly of link rod to bell-crank ; re-adjust as necessary.

Lost motion is incorporated in the linkage to allow 'fast idle', when choke is applied, without disturbing the closed position on the accelerator linkage.

Check fast idle clearance after initial tuning is completed by placing a piece of $\frac{3}{16}$ " (4.7 mm.) dia. bar in the quadrant slot as shown in the inset.

CARBURETTOR JET ADJUSTING TOOLS IN POSITION

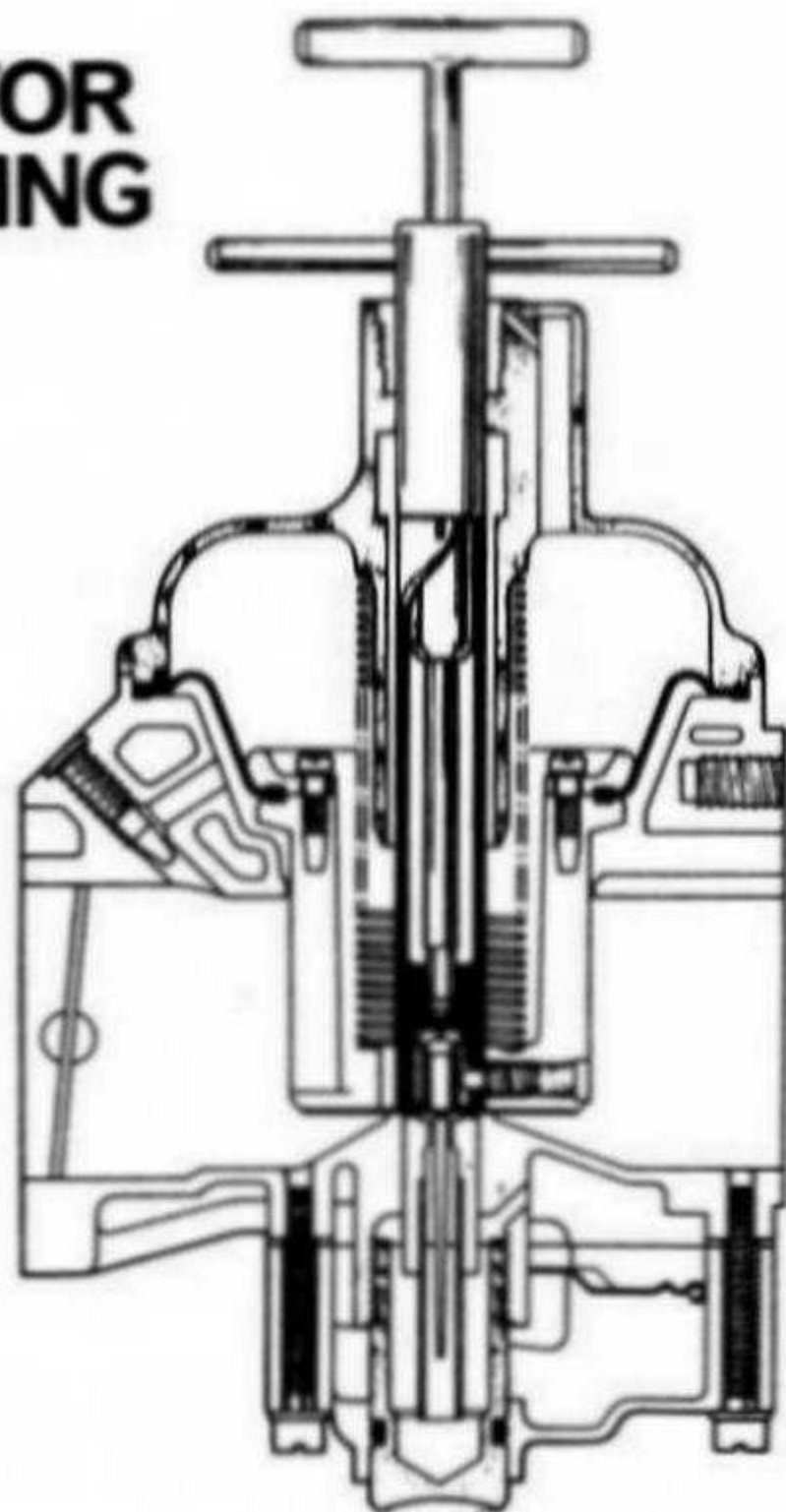

72

FRAME 72

CARBURETTOR NEEDLE ADJUSTMENT THROUGH THE TOP COVER

Provision is made to adjust the air/fuel ratio by moving the carburettor needle using the special tools shown above.

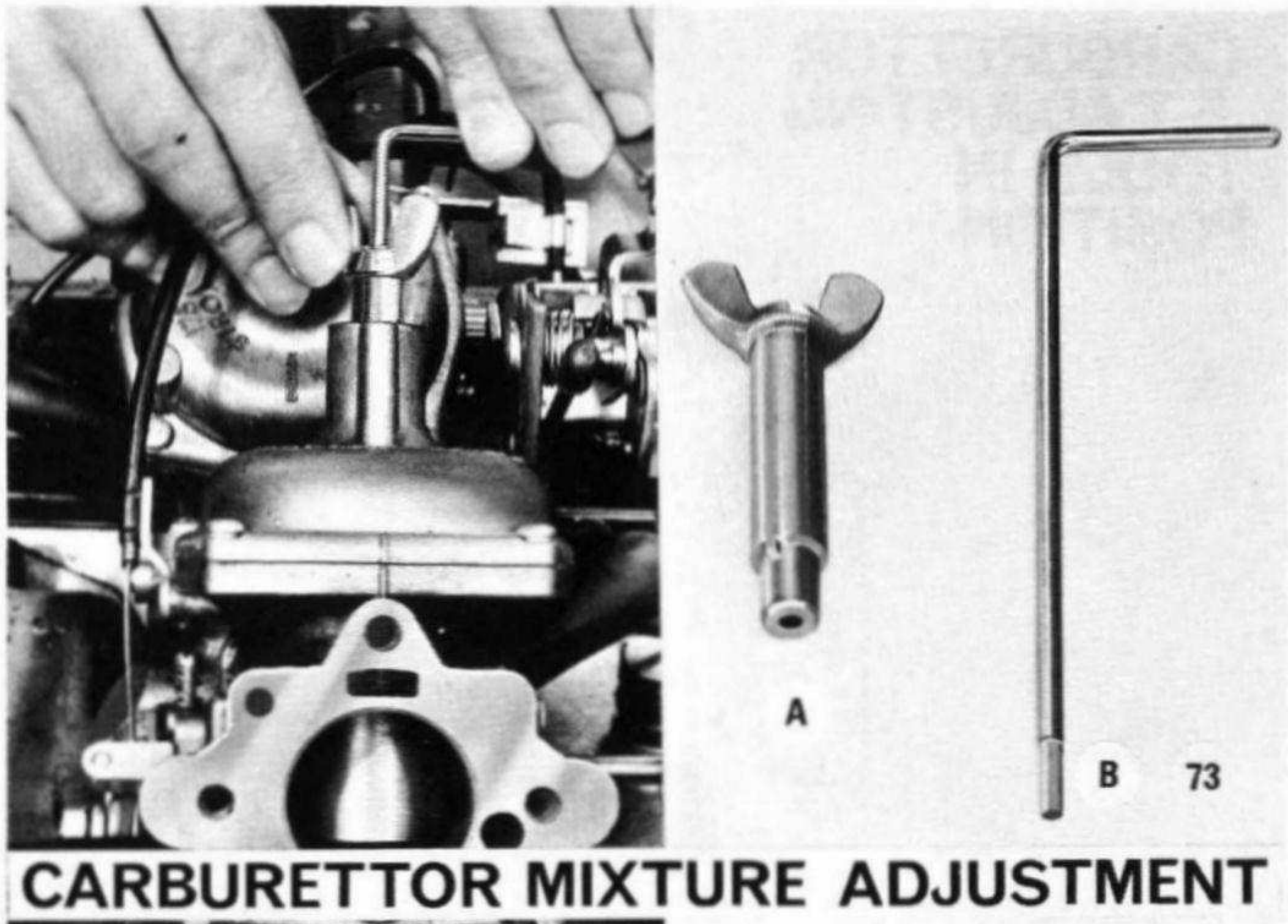

CARBURETTOR MIXTURE ADJUSTMENT

FRAME 73

CARBURETTOR MIXTURE ADJUSTMENT

NOTE: In certain European countries with regulations governing EXHAUST EMISSION CONTROL, it is ESSENTIAL that the carburettors are adjusted in conjunction with a C.O. Meter to ensure legal requirements are not exceeded. Idle C.O. Level, engine warm $4\frac{1}{2}\%$. Equivalent air/fuel ratio at idle (approx.) 12.8 : 1.

Check the mixture on each carburettor by lifting the air valve $\frac{1}{32}$ " (0.8 mm.) and noting engine reaction.

- (a) Increase in speed indicates rich mixture.
- (b) Decrease in speed and engine stall indicates lean mixture.
- (c) Slight increase in engine speed, then a fall-off, indicates an ideal economical mixture.

To adjust the air/fuel mixture unscrew the damper from the carburettor top cover and, to prevent loss of damper oil, slowly insert tool 'A' until the lugs engage with the slots in the air valve tube. Insert tool 'B' through the centre of 'A', which automatically centres the hexagonal end of tool 'B' to engage with the screw adjustment at the bottom of the air valve tube.

To richen the mixture hold tool 'A' to prevent the air valve turning and rotate tool 'B' in a clockwise direction by increments of a quarter of a turn.

To weaken the mixture turn tool 'B' in an anti-clockwise direction.

There is approximately one full turn in each direction.

Remove the special tools, check carburettor air valve damper oil level, and replace damper.

To finally check mixture replace air cleaner and elbows, reset idling if necessary to 600–650 r.p.m. and blip throttle.

If engine stalls, richen mixture by a quarter turn on each carburettor.

ALTERNATOR ASSEMBLY

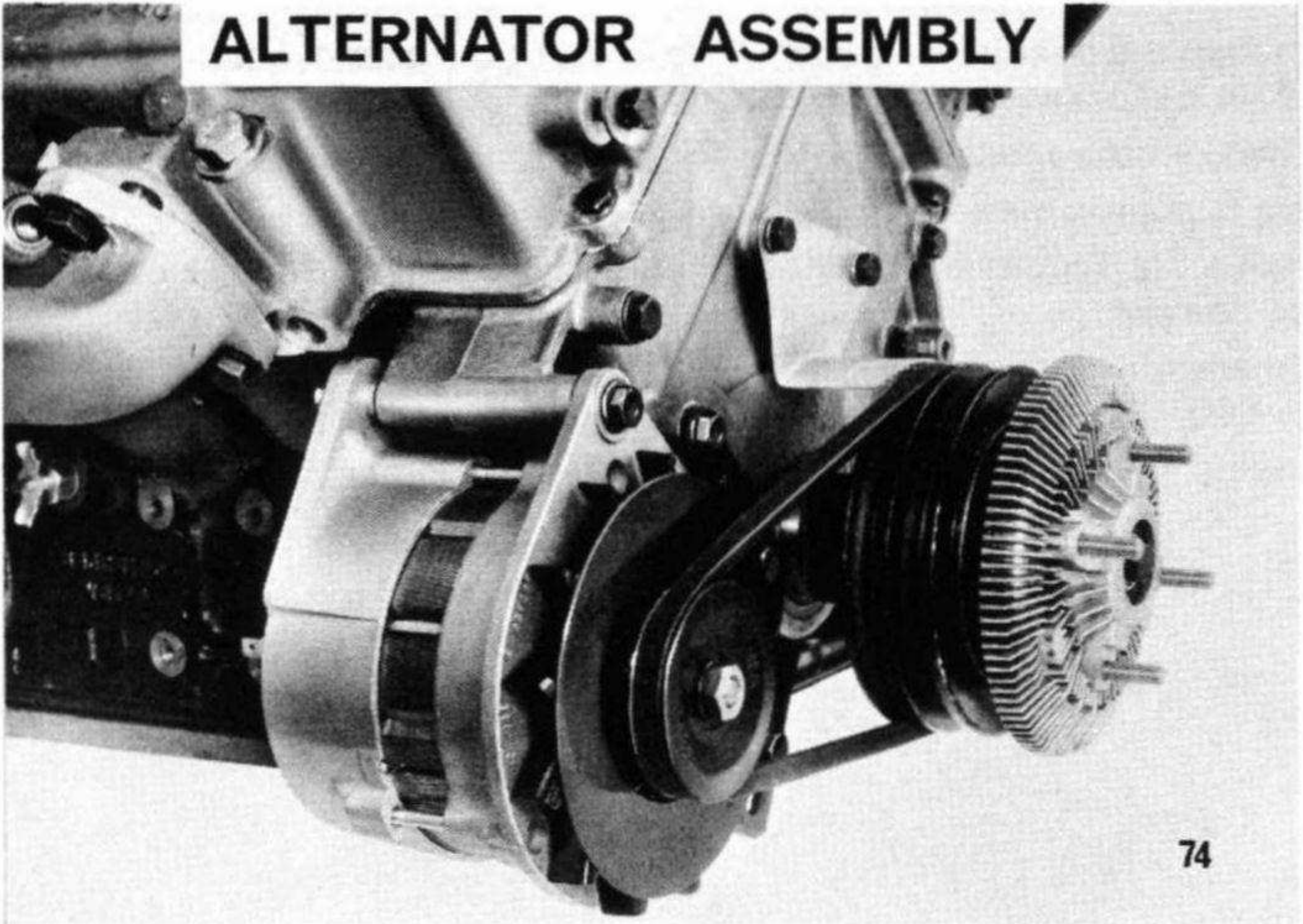

FRAME 74

PART 7

ALTERNATOR

The alternator is the Lucas 11AC type and is secured to the front timing cover by a single long bolt, two plain washers and a self-locking nut.

The bottom mounting lug on the alternator is attached to the adjustment bracket.

DRIVE BELT ADJUSTMENT

Slacken alternator securing bolts and apply tension to the belt until there is $\frac{1}{2}$ " (12.7 mm.) movement at the mid point on one side of the drive belt.

Maintaining the alternator in this position, tighten securing bolts.

FAN TORQUE CONTROL UNIT

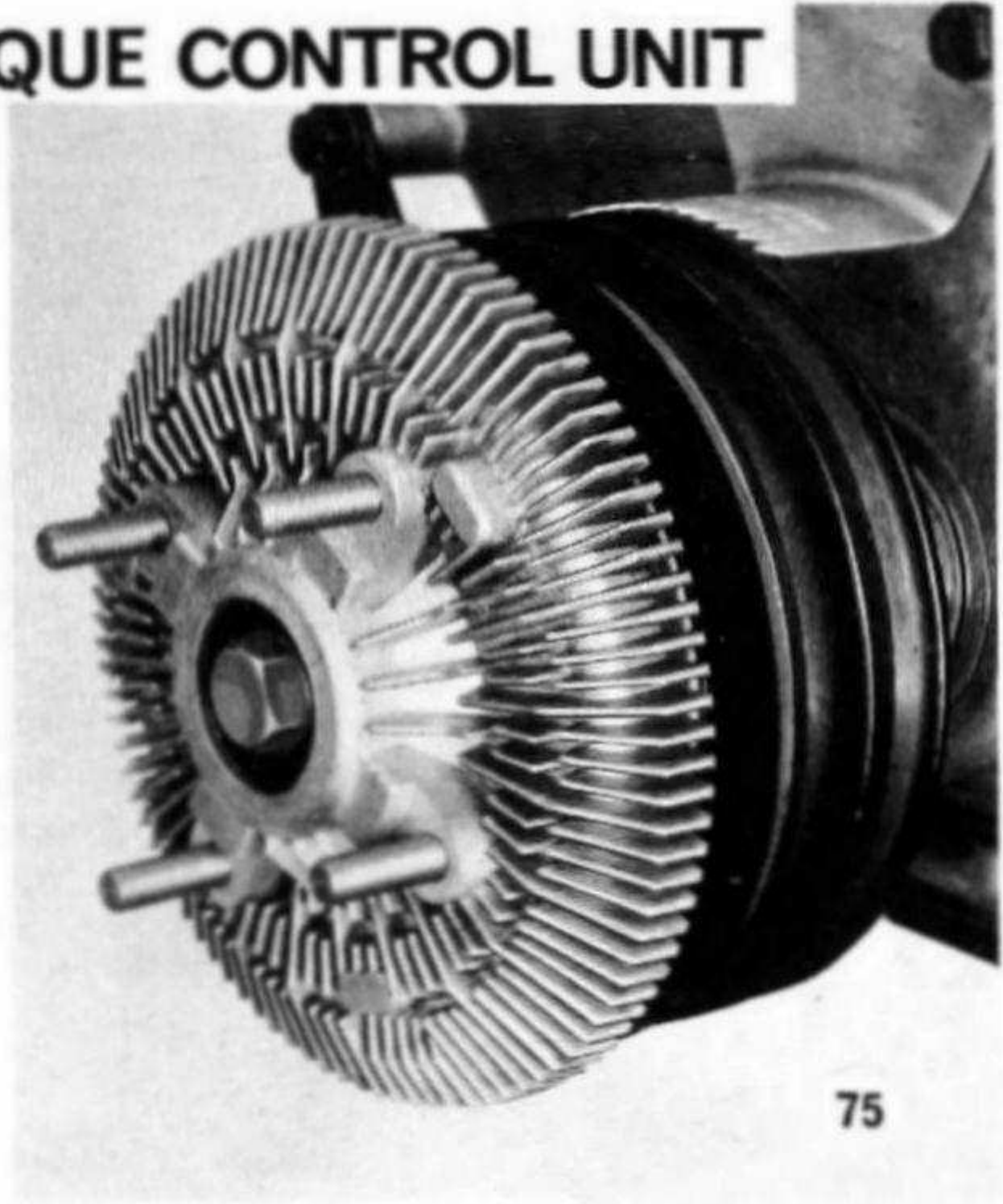
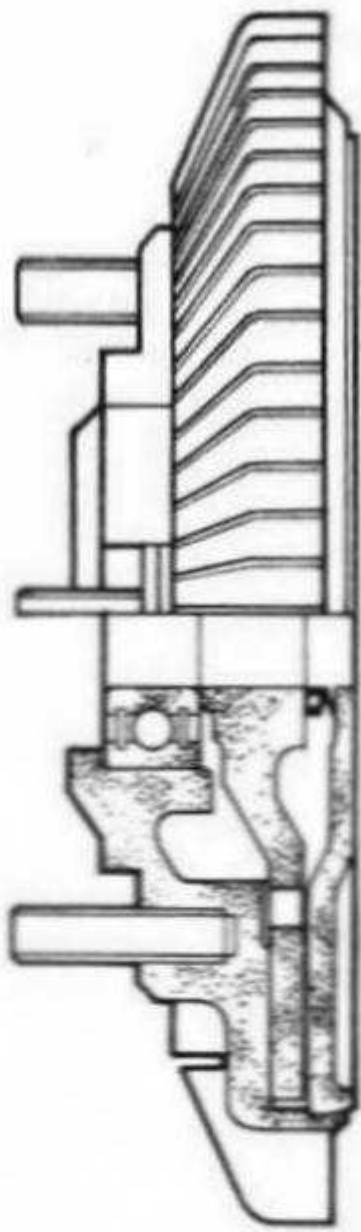

FRAME 75

PART 8

TORQUE CONTROL UNIT

The torque control unit, which is secured to the crankshaft and damper assembly, limits the speed of the fan to 2,500 r.p.m.

Automatically controlling the maximum speed of the fan saves b.h.p. at high engine revs and reduces fan noise. The unit is maintenance-free.

The torque control unit operates on the shear-type fluid coupling principle.

The drive is transmitted from the driving disc to the housing by a film of silicone fluid.

When the maximum fan speed is reached, according to the viscosity of the silicone fluid used, the fan assembly drive capability remains constant irrespective of increased engine speed.

The torque control unit is secured to the crankshaft by a bolt and washer tightened to 90–110 lb. ft. (12.4–15.1 kg. m.).

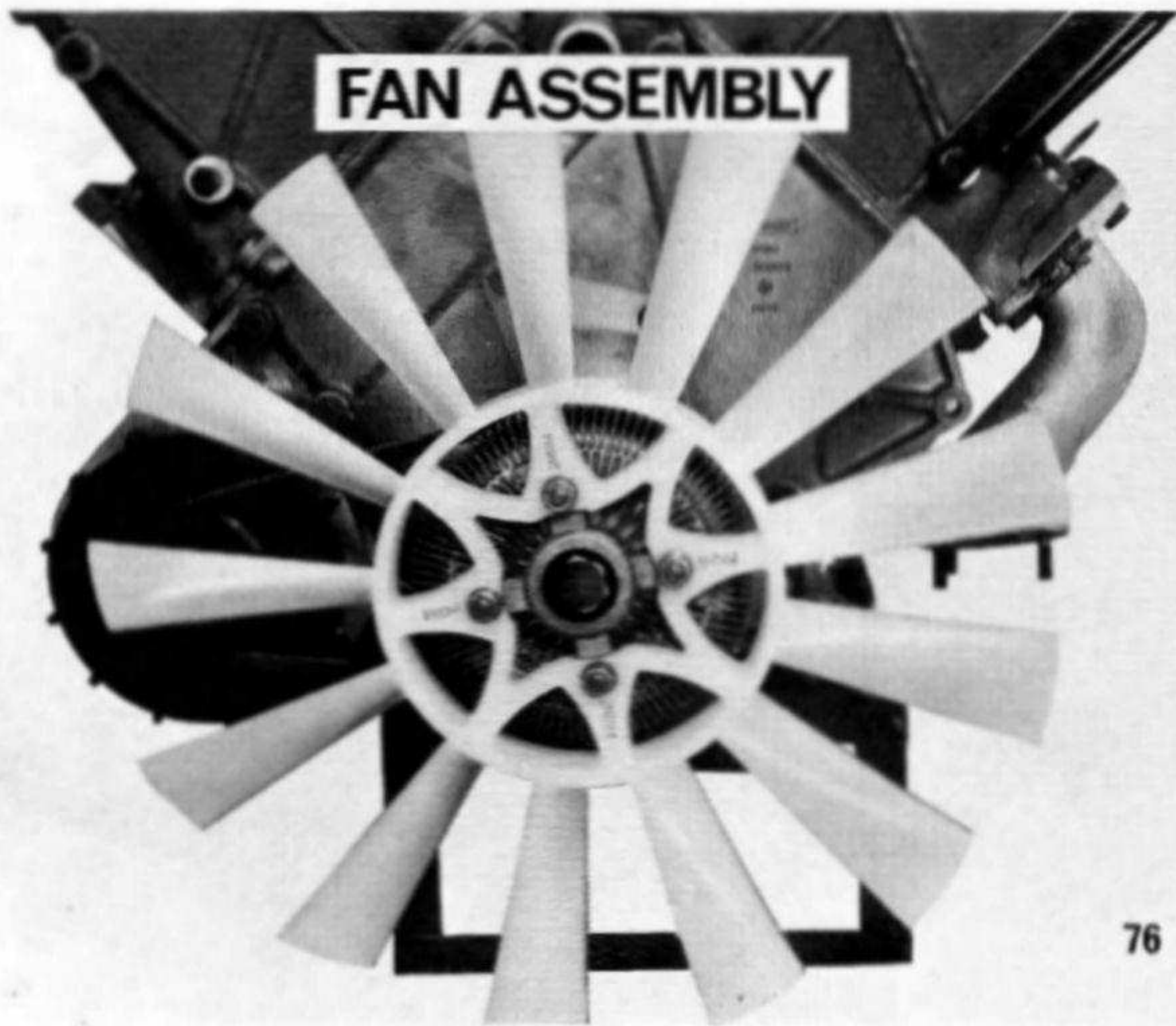

FRAME 76

FAN ASSEMBLY

The fan is secured to the torque control unit by four nuts and washers tightened to 11–14 lb. ft. (1.5–1.9 kg. m.).

NOTE: The fan is marked FRONT on each of four segments on the mounting boss.

THERMOSTAT AND HOUSING

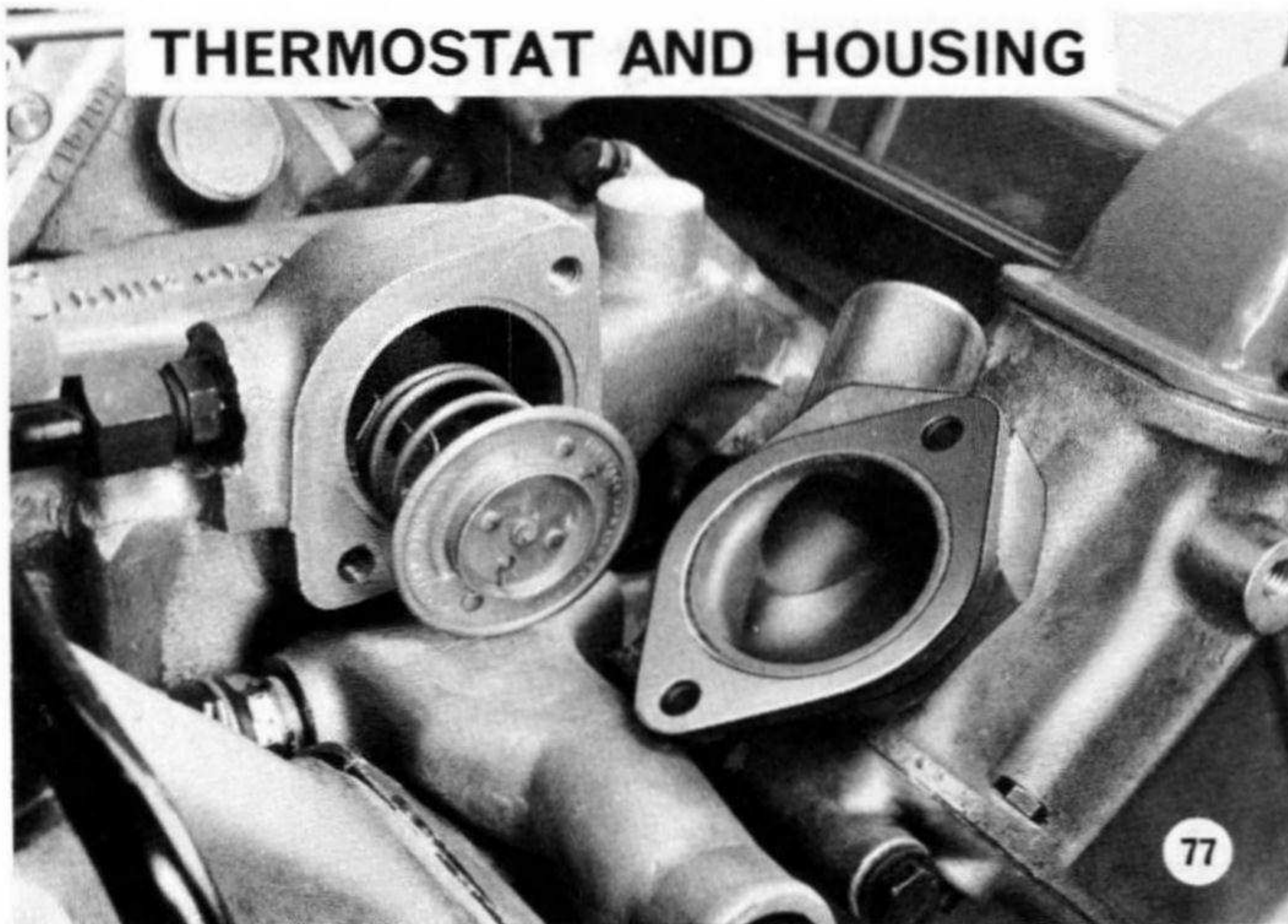

FRAME 77

PART 9

THERMOSTAT AND HOUSING

The thermostat housing is integral with the inlet manifold.

The thermostat is held in position by an elbow secured with two bolts and washers and the assembly is sealed by a gasket.

The thermostat starts to open between 79–83°C. (175–180°F.) and is fully open at 93.5–96°C. (200–205°F.).

The cooling system is of the 'NO LOSS' type and is pressurized to 13 lb./sq. in. (0.9 kg./cm.²). On later cars the cooling system pressure has been increased to 20 lb./sq. in. (1.4 kg./sq. cm.) from Commission No. LE 11277 LDL onwards.

NOTE: It is most important to use an ANTI-FREEZE specially made for use with aluminium components.

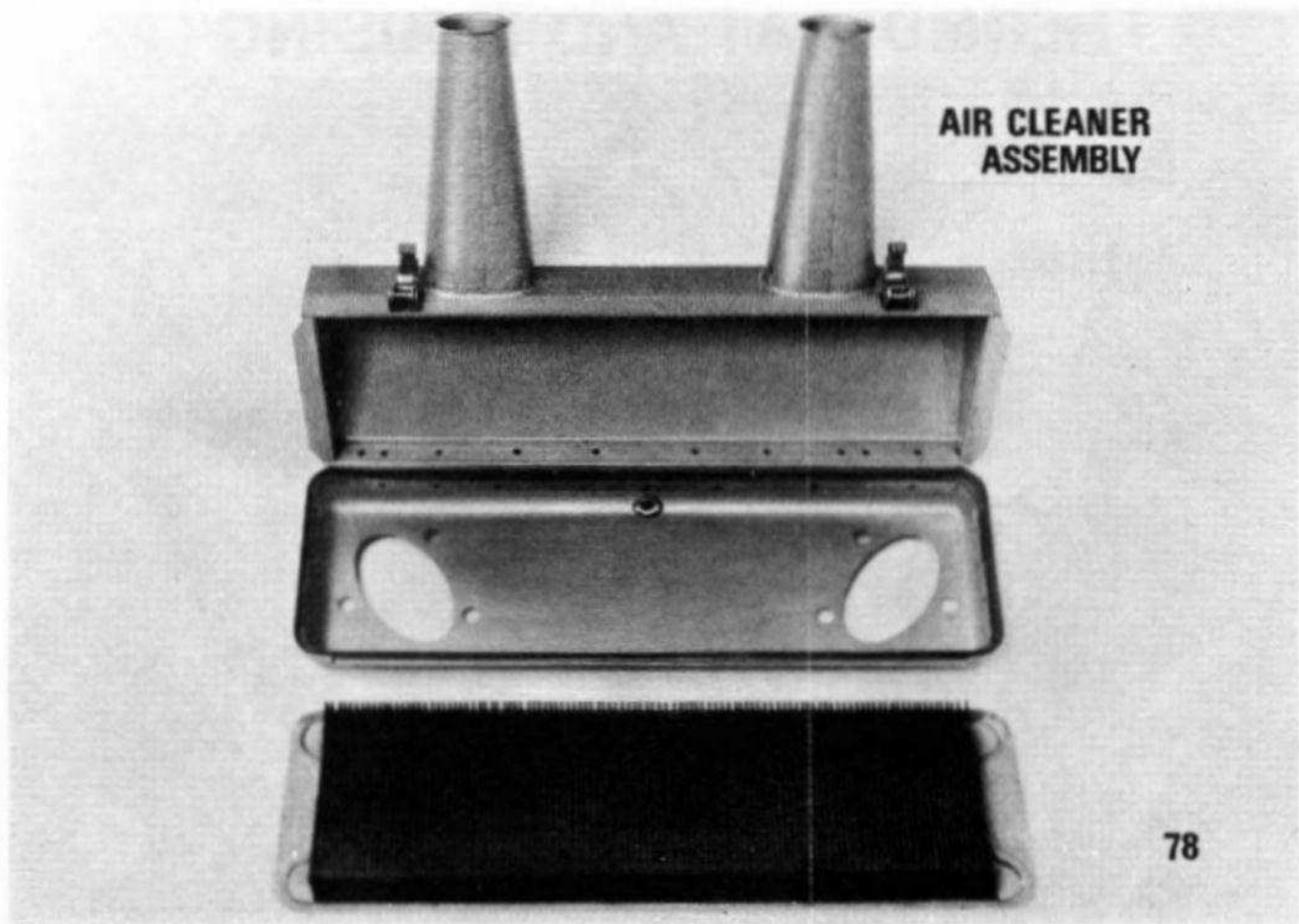

FRAME 78

PART 10

AIR CLEANER

The air cleaner element is of the paper type which may be cleaned using dry compressed air, at 6,000 mile (10000 km.) intervals. Replace the element at 12,000 miles (20000 km.).

The element may require more frequent cleaning and replacement than those quoted according to climatic and operational conditions.

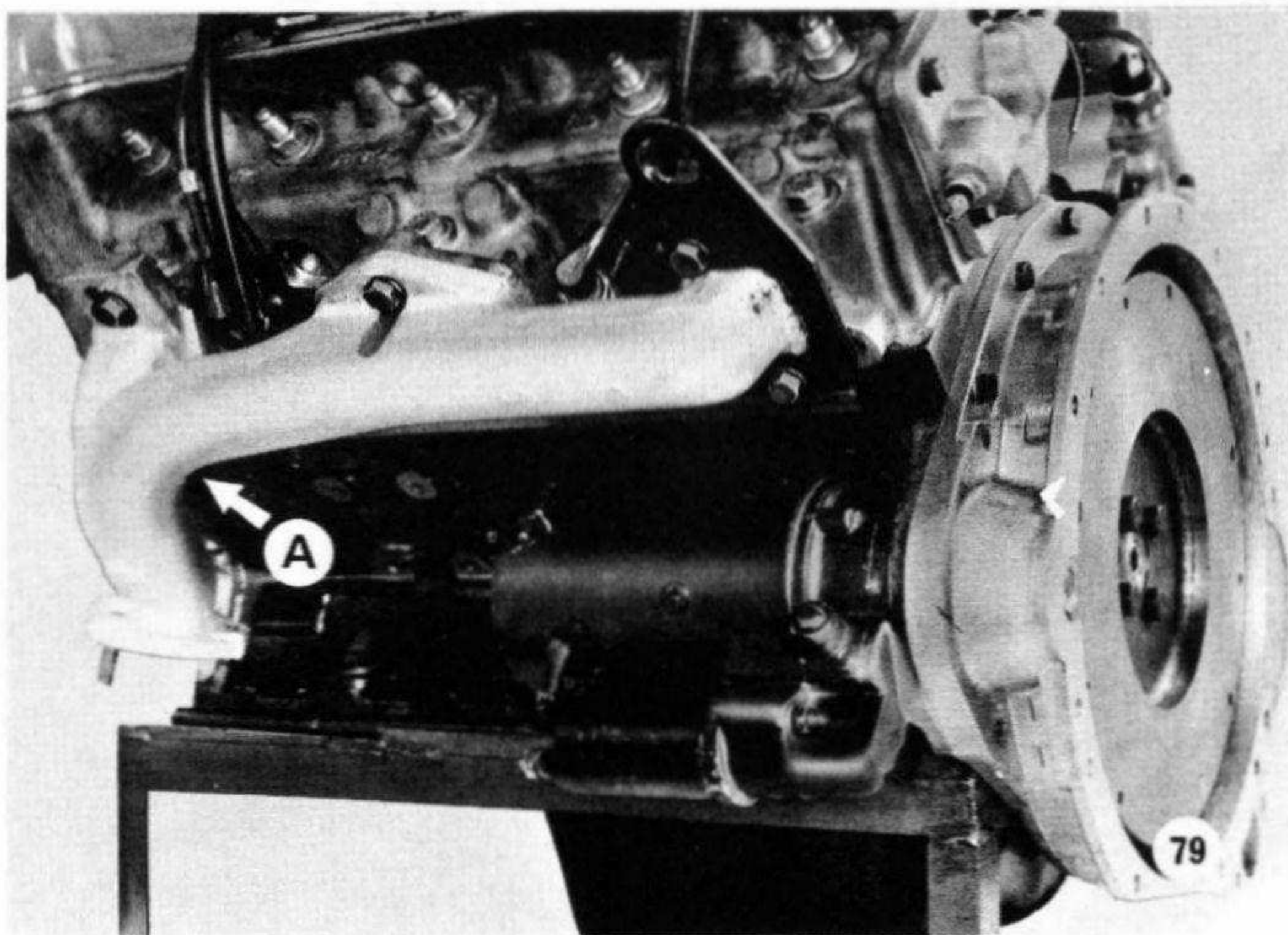

FRAME 79

PART 11

EXHAUST MANIFOLDS

The exhaust manifolds are secured to the cylinder heads by seven bolts and spring washers.

A short bolt is fitted to the front flange 'A' of the left-hand manifold shown in the illustration.

There are no gaskets fitted between the manifold and head.

An engine lifting eye is fitted to the two rearmost manifold securing bolts.

The outer four bolts should be tightened to 16–20 lb. ft. (2.2–2.8 kg. m.).

The inner three bolts should be tightened to 26–28 lb. ft. (3.6–3.9 kg. m.).

STARTER MOTOR

The starter motor is of the pre-engaged type Lucas M418G and is secured to the extension casing by two bolts and spring washers tightened to 28–30 lb. ft. (3.9–4.1 kg. m.).

WATER PUMP EXTRACTOR



FRAME 80

PART 12

WATER PUMP REMOVAL

Apply a socket spanner to the bolt head, which has a left-hand thread, and gently rock in a clockwise direction with the idler shaft held stationary. If complete assembly does not disengage itself from the cylinder block due to tightness, the bolt securing the impeller will unscrew. The special adaptor, part number S4235A/6 should be screwed into the water pump shaft and, by using an impact hammer part number S4235A (equivalent No. 3072), the pump assembly is withdrawn from the block.

NOTE: In certain circumstances the body of the water pump may be left in the block although the impeller, shaft bearing, etc., has been removed. It will then be necessary to break up the housing *in situ* using a small chisel very carefully to avoid damaging the pump body seat.

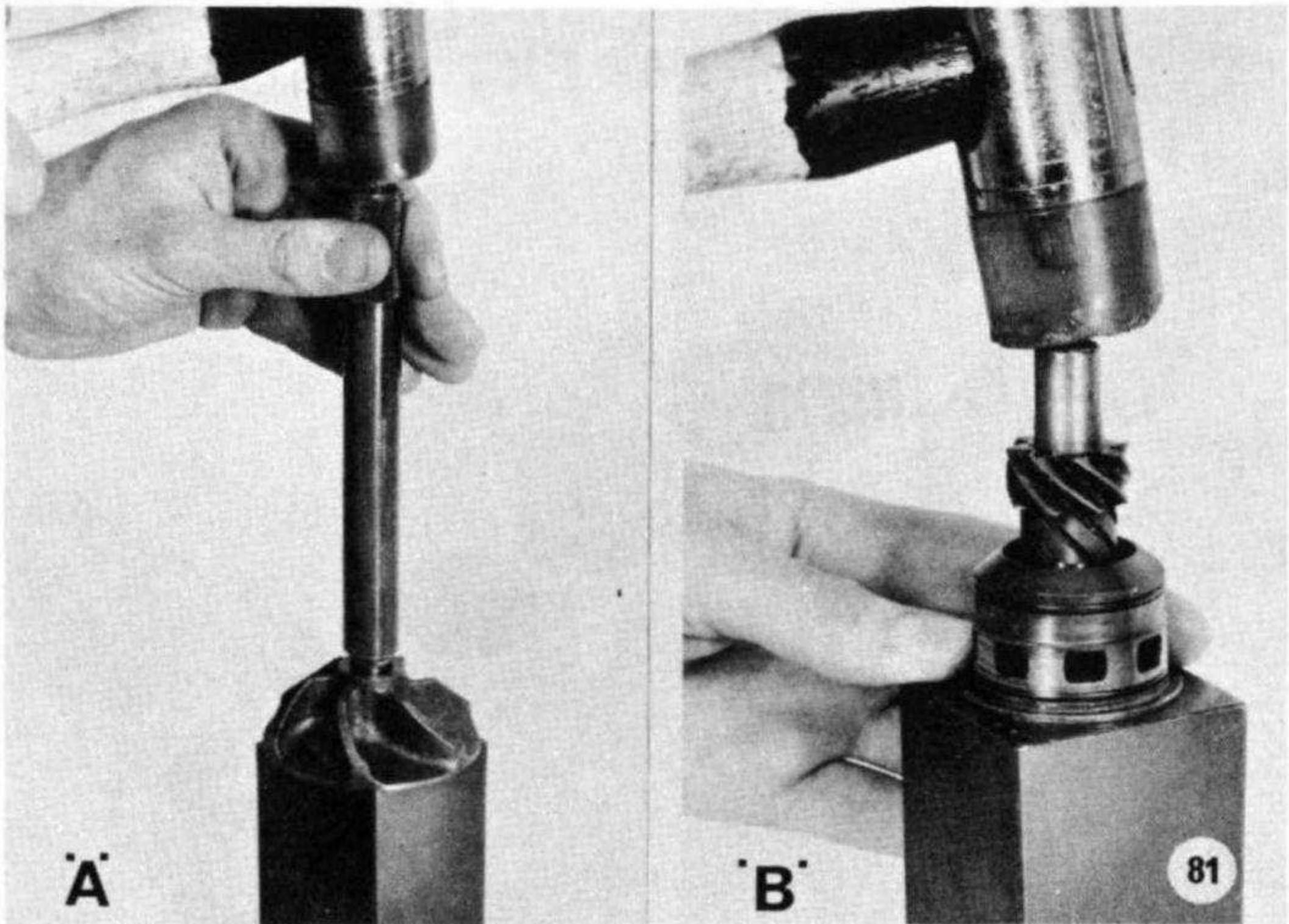

FRAME 81

WATER PUMP DISMANTLING AND RECONDITIONING

Remove the left-hand thread bolt and washer securing the impeller to the shaft.

Place the water pump assembly into the large hole of the dismantling tool No. 348/1 and using tool No. 348/6 drift out the water pump shaft from the impeller as shown in illustration 'A'.

Using small hole in tool No. 348/1, place pump assembly in position as shown in 'B'.

Drift pump shaft from housing.

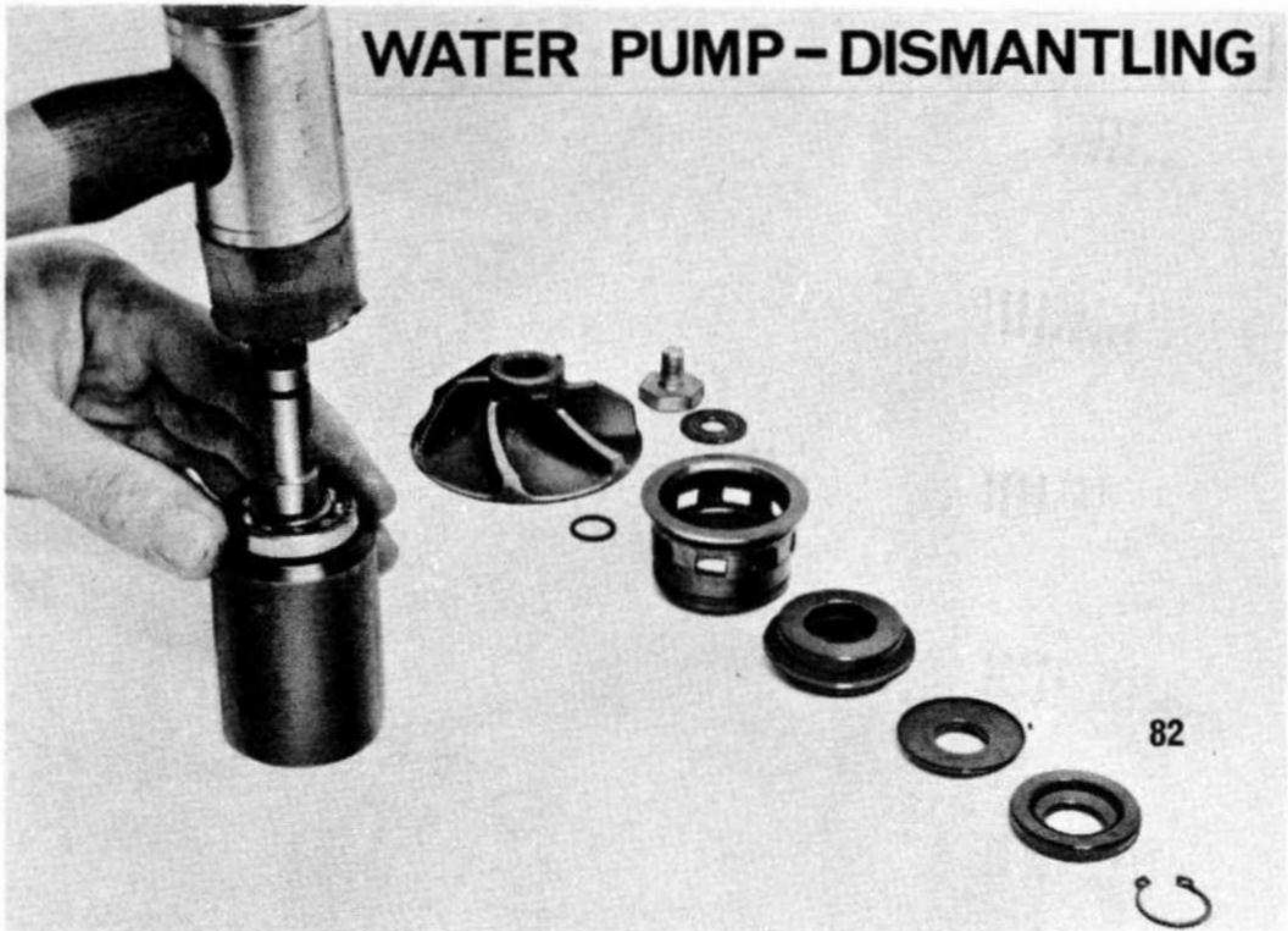

FRAME 82

Remove the rubber 'O' ring, graphite seal, water flinger, oil seal and circlip from the shaft.

Using the small hole in tool No. 348/7, place the shaft and bearing into position as shown.

Drift the shaft through the bearing and collect shaft, bearing and oil flinger.

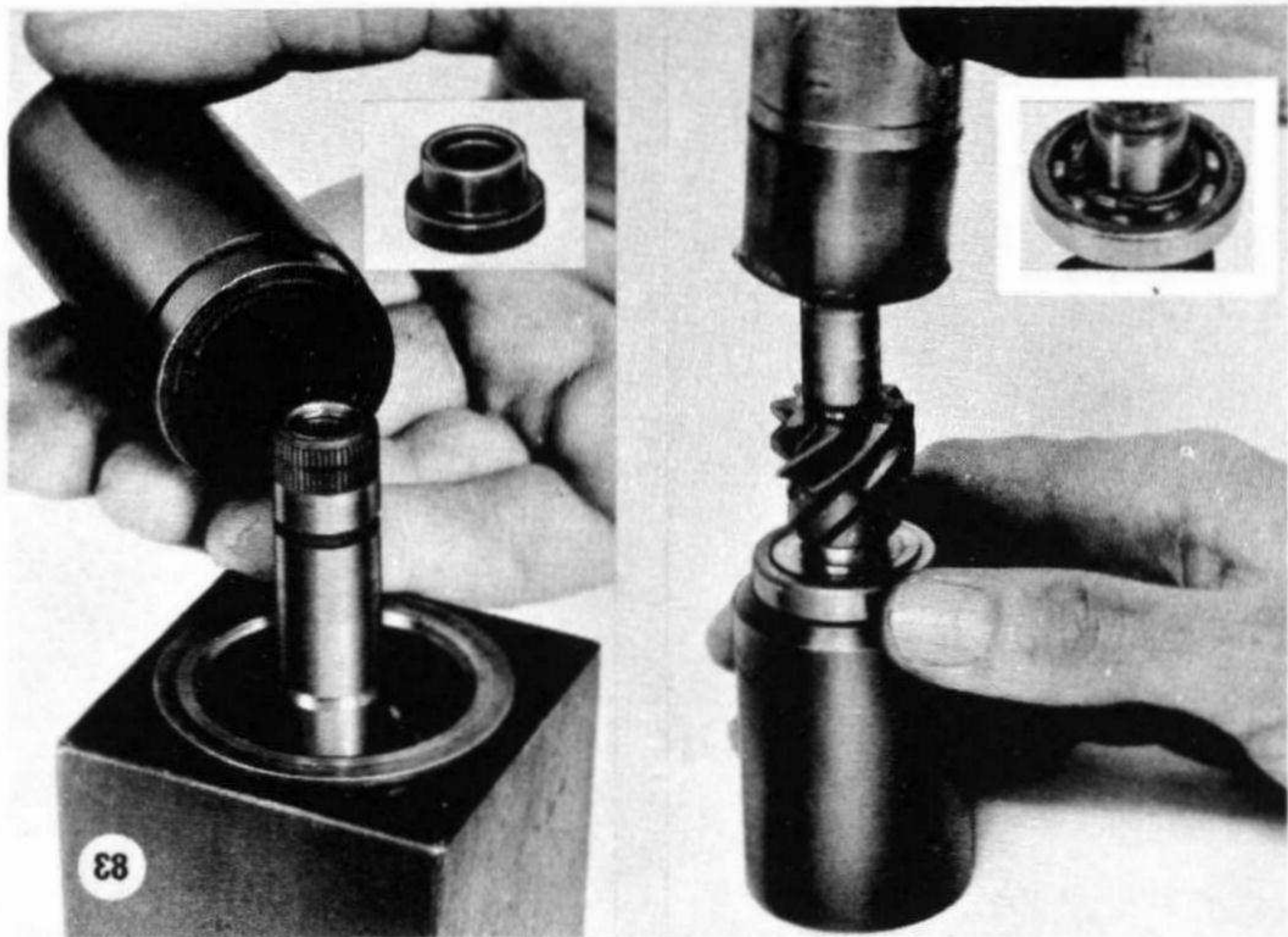

FRAME 83

When reassembling water pump, always fit new seals and bearing.

Refit oil flinger, dish face towards drive gear shaft.

Slide bearing into position on shaft, place shaft into small hole in tool No. 348/7 as shown in 'A', and drift bearing into position, care being taken to centralize oil flinger.

Fit circlip onto shaft.

Place water pump body into small hole of tool No. 348/1. Place shaft and bearing gear downwards into pump body.

Using tool No. 348/2, drift bearing and shaft into position in body.

Replace oil seal, spring uppermost, and tap gently into position using tool No. 348/2 in conjunction with tool No. 348/4 as shown in inset of 'B'.

NOTE: If unnecessary force is used, flinger will spread and foul pump body.

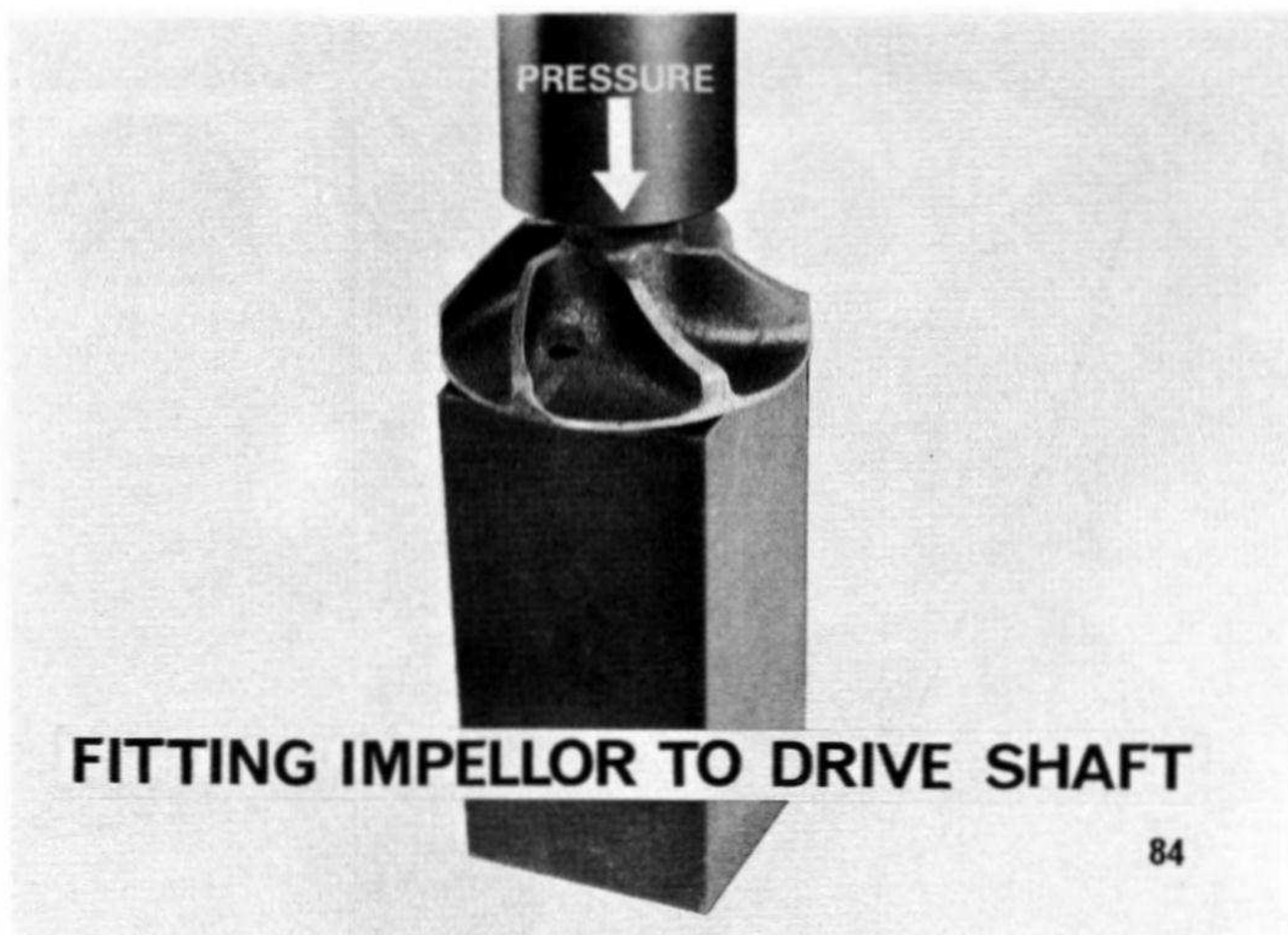

FITTING IMPELLOR TO DRIVE SHAFT

84

FRAME 84

Refit graphite seal, marking facing downwards.

Refit 'O' ring to shaft.

Place impeller into position on shaft and, using a suitable press, push impeller onto shaft until face of impeller is flush with shaft.

Refit washer and left-hand threaded bolt and tighten to 16–18 lb. ft. (2.2–2.5 kg. m.).

Refit two rubber 'O' rings to water pump body.

NOTE: Before replacing water pump assembly, examine bush in cylinder block for deterioration and replace as necessary.

NOTES



SALES AND SERVICE TRAINING CENTRE

**BRITISH LEYLAND UK LIMITED
RADFORD, COVENTRY, ENGLAND**

